

# STANT wall lamp - applique

Edmondo Testaguzza design

# AP264 GG INT

2021

**A - LAMP** *corpo lampada* matt black aluminum - *alluminio nero opaco*

**E - CEILING CUP** *rosone* matt black metal - *metallo nero opaco*

**ELECTRICAL CABLE** *cavo elettrico* black 2 meters - *2 metri nero*

**SUSPENSION CABLE** *fune* steel, 2 meters - *2 metri acciaio*

**OPTIONAL** *accessorio* 60W power supply equipped - *alimentatore incluso*

**ELECTRICAL SYSTEM**  
3x **80AC2641V** (LED 24V\*, 2,4W, 304 lm)  
1x **80AC2642V** (LED 24V\*, 8,4W, 907 lm)  
2x **80AC2643N** (LED 24V\*, 8,4W, 907 lm)

**PACKAGING** *imballo* supplied disassembled - *fornito smontato*

**IP RATE** *grado protezione* IP20

**CERTIFICATION** *conformità* IEC 60598-1:2014 EN 60598-1:2015

**EMISSION** *emissione* bidirectional - *bidirezionale*

 direct - *diretta*

 filtered - *filtrata*

 indirect - *indiretta*

 none - *assente*

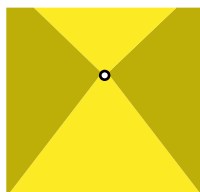

\*(0-10V dimmable - PWM - resistance)



**COLLECTION** *collezione*

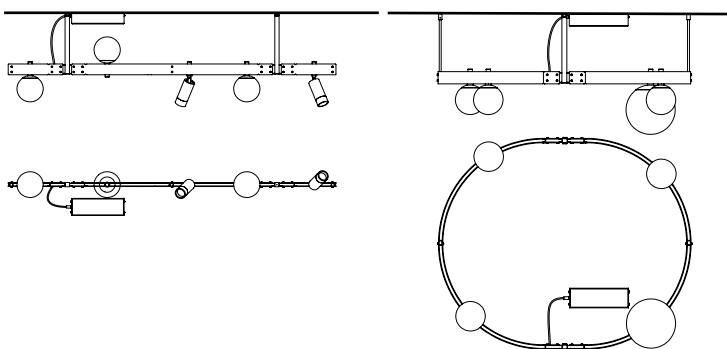

PL264 AA INT

PL264 BB INT

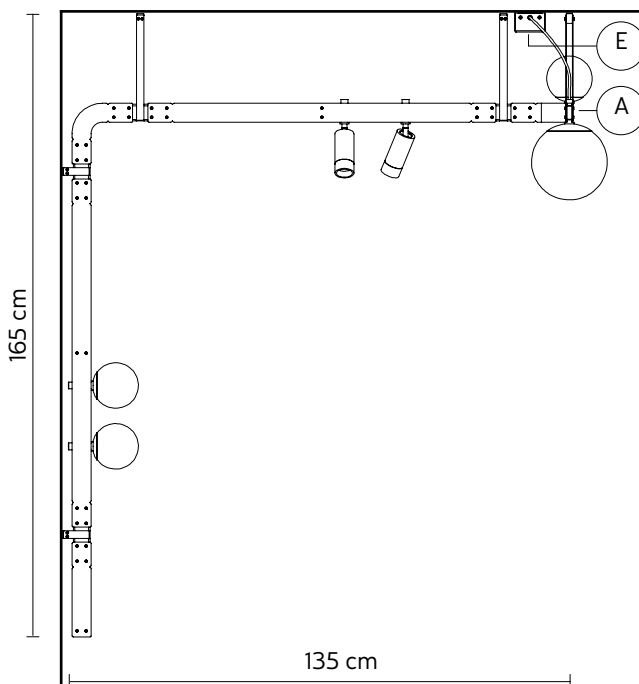

available suspension lamp version - *disponibile versione sospensione*

# STANT pendant - sospensione

Edmondo Testaguzza design

# SE264 AA INT

2021

**A - LAMP** *corpo lampada* matt black aluminum - *alluminio nero opaco*

**CEILING CUP** *rosone* matt black metal - *metallo nero opaco*

**ELECTRICAL CABLE** *cavo elettrico* black 2 meters - *2 metri nero*

**SUSPENSION CABLE** *fune* steel, 2 meters - *2 metri acciaio*

**OPTIONAL** *accessorio* 60W power supply equipped - *alimentatore incluso*

**ELECTRICAL SYSTEM** 3x **80AC2641V** (LED 24V\*, 2,4W, 304 lm)  
2x **80AC2643N** (LED 24V\*, 8,4W, 907 lm)

**PACKAGING** *imballo* supplied disassembled - *fornito smontato*

**IP RATE** *grado protezione* IP20

**CERTIFICATION** *conformità* IEC 60598-1:2014 EN 60598-1:2015

**EMISSION** *emissione* bidirectional - *bidirezionale*

 direct - *diretta*

 filtered - *filtrata*

 indirect - *indiretta*

 none - *assente*

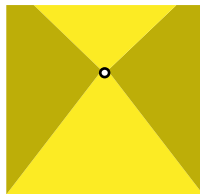

\*(0-10V dimmable - PWM - resistance)



**COLLECTION** *collezione*

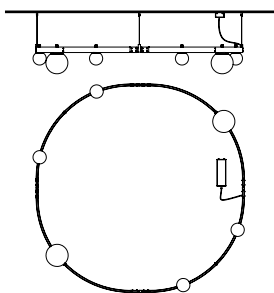

SE264 CC INT

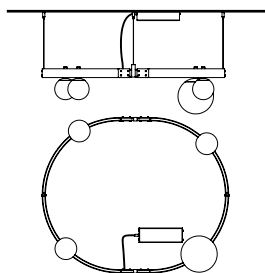

SE264 BB INT

available ceiling lamp version - *disponibile versione plafoniera*

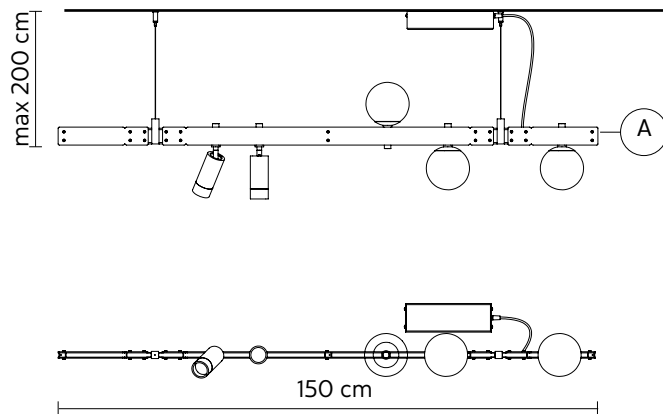

# STANT pendant - sospensione

Edmondo Testaguzza design

# SE264 BB INT

2021

**A - LAMP** *corpo lampada* matt black aluminum - *alluminio nero opaco*

**CEILING CUP** *rosone* matt black metal - *metallo nero opaco*

**ELECTRICAL CABLE** *cavo elettrico* black 2 meters - *2 metri nero*

**SUSPENSION CABLE** *fune* steel, 2 meters - *2 metri acciaio*

**OPTIONAL** *accessorio* 60W power supply equipped - *alimentatore incluso*

**ELECTRICAL SYSTEM**  
3x **80AC2641V** (LED 24V\*, 2,4W, 304 lm)  
1x **80AC2642V** (LED 24V\*, 8,4W, 907 lm)

**PACKAGING** *imballo* supplied disassembled - *fornito smontato*

**IP RATE** *grado protezione* IP20

**CERTIFICATION** *conformità* IEC 60598-1:2014 EN 60598-1:2015

**EMISSION** *emissione* bidirectional - *bidirezionale*

 direct - *diretta*

 filtered - *filtrata*

 indirect - *indiretta*

 none - *assente*

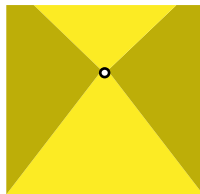

\*(0-10V dimmable - PWM - resistance)



**COLLECTION** *collezione*

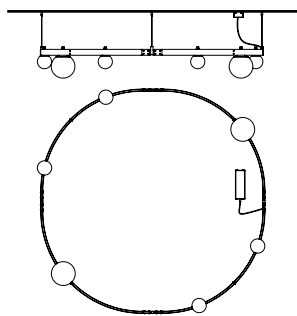

SE264 CC INT

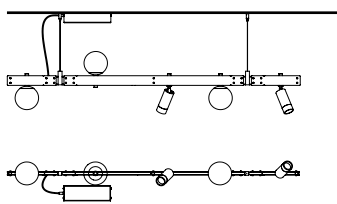

SE264 AA INT

available ceiling lamp version - *disponibile versione plafoniera*

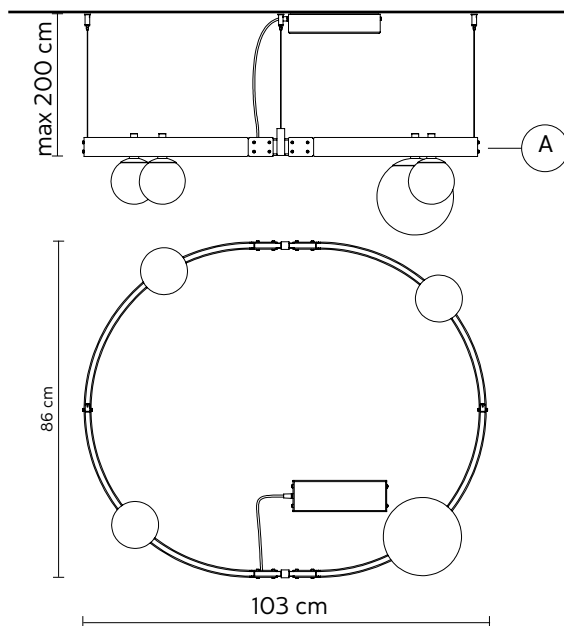

# STANT pendant - sospensione

Edmondo Testaguzza design

# SE264 CC INT

2021

**A - LAMP** *corpo lampada* matt black aluminum - *alluminio nero opaco*

**CEILING CUP** *rosone* matt black metal - *metallo nero opaco*

**ELECTRICAL CABLE** *cavo elettrico* black 2 meters - *2 metri nero*

**SUSPENSION CABLE** *fune* steel, 2 meters - *2 metri acciaio*

**OPTIONAL** *accessorio* 60W power supply equipped - *alimentatore incluso*

**ELECTRICAL SYSTEM** 4x **80AC2641V** (LED 24V\*, 2,4W, 304 lm)  
2x **80AC2642V** (LED 24V\*, 8,4W, 907 lm)

**PACKAGING** *imballo* supplied disassembled - *fornito smontato*

**IP RATE** *grado protezione* IP20

**CERTIFICATION** *conformità* IEC 60598-1:2014 EN 60598-1:2015

**EMISSION** *emissione* bidirectional - *bidirezionale*

 direct - *diretta*

 filtered - *filtrata*

 indirect - *indiretta*

 none - *assente*

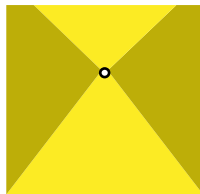

\*(0-10V dimmable - PWM - resistance)



**COLLECTION** *collezione*

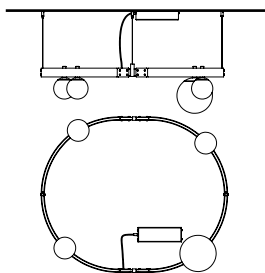

SE264 BB INT

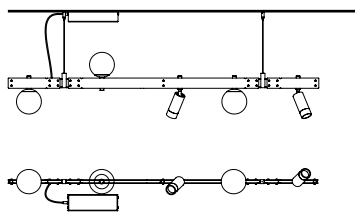

SE264 AA INT

available ceiling lamp version - *disponibile versione plafoniera*

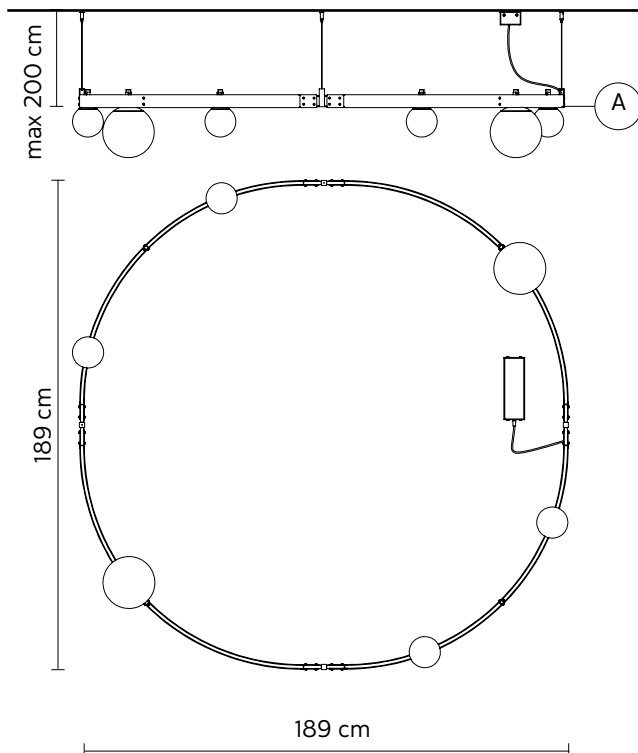

# STANT pendant - sospensione

Edmondo Testaguzza design

# SE264 DD INT

2021

**A - LAMP** *corpo lampada* matt white aluminum - *alluminio bianco opaco*

**CEILING CUP** *rasone* matt white metal - *metallo bianco opaco*

**ELECTRICAL CABLE** *cavo elettrico* black 2 meters - *2 metri nero*

**SUSPENSION CABLE** *fune* steel, 2 meters - *2 metri acciaio*

**OPTIONAL** *accessorio* 60W power supply equipped - *alimentatore incluso*

**ELECTRICAL SYSTEM** 3x **80AC2641V** (LED 24V\*, 2,4W, 304 lm)  
2x **80AC2643B** (LED 24V\*, 8,4W, 907 lm)

**PACKAGING** *imballo* supplied disassembled - *fornito smontato*

**IP RATE** *grado protezione* IP20

**CERTIFICATION** *conformità* IEC 60598-1:2014 EN 60598-1:2015

**EMISSION** *emissione* bidirectional - *bidirezionale*

 direct - *diretta*

 filtered - *filtrata*

 indirect - *indiretta*

 none - *assente*

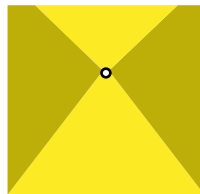

\*(0-10V dimmable - PWM - resistance)



**COLLECTION** *collezione*

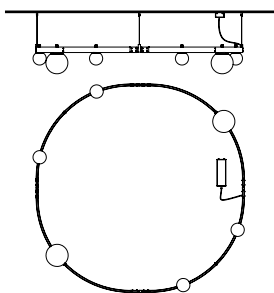

SE264 FF INT

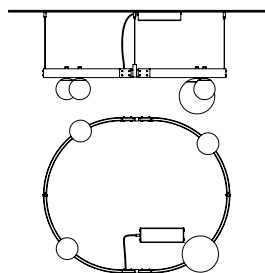

SE264 EE INT

available ceiling lamp version - *disponibile versione plafoniera*

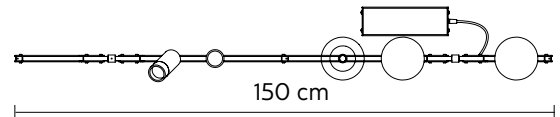
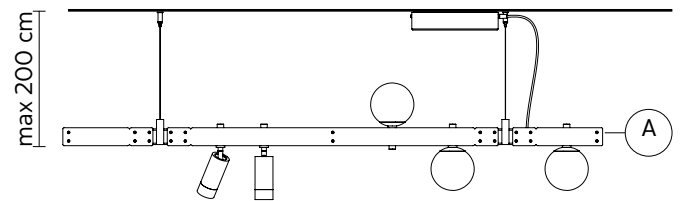

# STANT pendant - sospensione

Edmondo Testaguzza design

# SE264 EE INT

2021

**A - LAMP** *corpo lampada* matt white aluminum - *alluminio bianco opaco*

**CEILING CUP** *rasone* matt white metal - *metallo bianco opaco*

**ELECTRICAL CABLE** *cavo elettrico* black 2 meters - *2 metri nero*

**SUSPENSION CABLE** *fune* steel, 2 meters - *2 metri acciaio*

**OPTIONAL** *accessorio* 60W power supply equipped - *alimentatore incluso*

**ELECTRICAL SYSTEM**  
3x **80AC2641V** (LED 24V\*, 2,4W, 304 lm)  
1x **80AC2642V** (LED 24V\*, 8,4W, 907 lm)

**PACKAGING** *imballo* supplied disassembled - *fornito smontato*

**IP RATE** *grado protezione* IP20

**CERTIFICATION** *conformità* IEC 60598-1:2014 EN 60598-1:2015

**EMISSION** *emissione* bidirectional - *bidirezionale*

 direct - *diretta*

 filtered - *filtrata*

 indirect - *indiretta*

 none - *assente*

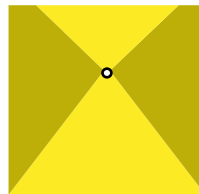

\*(0-10V dimmable - PWM - resistance)

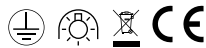

**COLLECTION** *collezione*

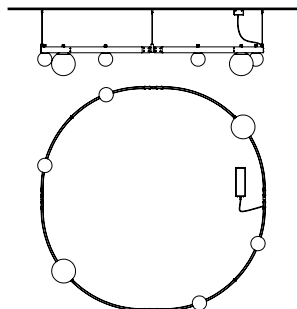

SE264 FF INT

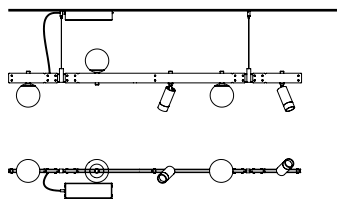

SE264 DD INT

available ceiling lamp version - *disponibile versione plafoniera*

