

CERAUNAVOLTA suspension lamp 12 elements

Matteo Ugolini & Edmondo Testaguzza design

year 2018

DATA SHEET - SE134 2T 00A

LAMPSHADE "A"

material glass
colour tiffany



CEILING CUP "E"

material metal
colour matt white

ELECTRICAL CABLE "C"

colour transparent



SUSPENSION CABLE "F"

material metal

PACKAGING

net weight/kg 9,2

ELECTRICAL SYSTEM

socket E27
source 3 x max 20W LED
energy class from A to A++

LIGHT EMISSION

unidirectional

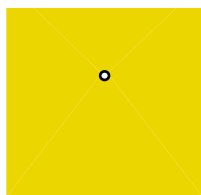

COMPLIANT WITH

IEC 60598-1:2014
EN 60598-1:2015



degree of protection IP20
bulb not provided

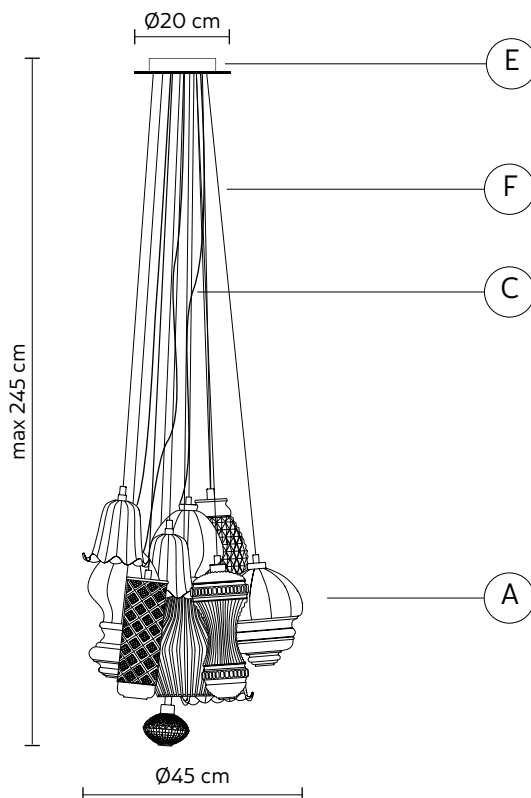

COLLECTION

also available modular/single version suspension lamp and transparent colour



SE134 2S 00A



SE134 3S 00C



SE134 3T 00C



SE134 1S 00D



SE134 1T 00D

CERAUNAVOLTA suspension lamp 17 elements

Matteo Ugolini & Edmondo Testaguzza design

year 2018

DATA SHEET - **SE134 3S 00C**

LAMPSHADE "A"

material glass
colour transparent



CEILING CUP "E"

material metal
colour matt white

ELECTRICAL CABLE "C"

colour transparent



SUSPENSION CABLE "F"

material metal

PACKAGING

net weight/kg 13

ELECTRICAL SYSTEM

socket E27
source 3 x max 20W LED
energy class from A to A++

LIGHT EMISSION

unidirectional

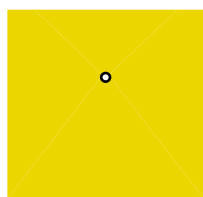

-  direct
-  filtered
-  indirect
-  absence

COMPLIANT WITH

IEC 60598-1:2014
EN 60598-1:2015



degree of protection IP20
bulb not provided

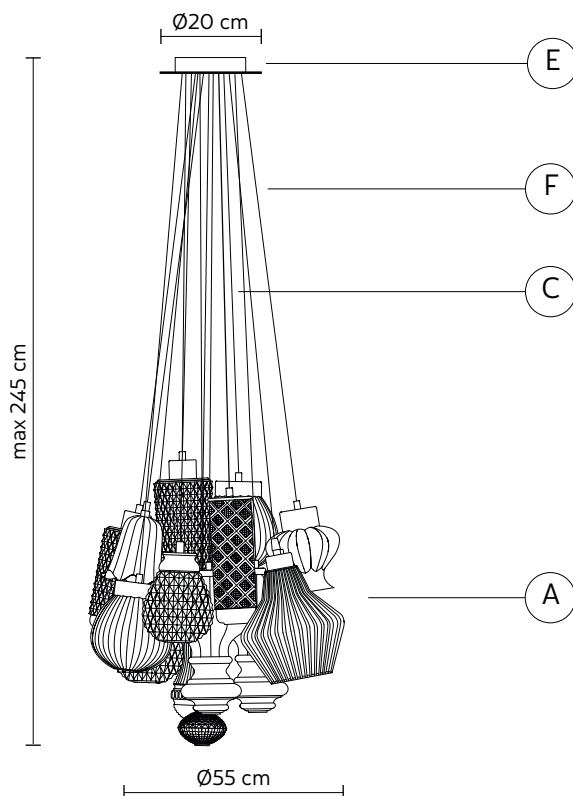

COLLECTION

also available modular/single version
suspension lamp and tiffany colour

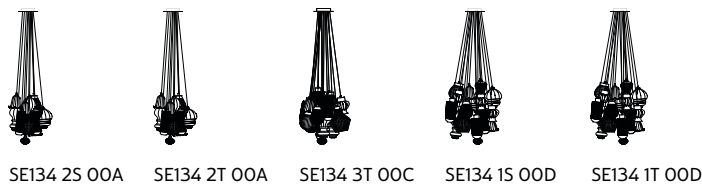

CERAUNAVOLTA personalized suspension lamp

Matteo Ugolini & Edmondo Testaguzza design

year 2016/2018

DATA SHEET - SE134 2S INT

ceiling cup + 3 sockets E27
for personalized composition

CEILING CUP "E"

material metal
colour matt white

lampshades in transparent and tuffany glass

ELECTRICAL CABLE "C"

colour transparent



ELECTRICAL SYSTEM

socket E27
source 3 x max 20W LED
energy class from A to A++

PACKAGING

net weight/kg 2,5

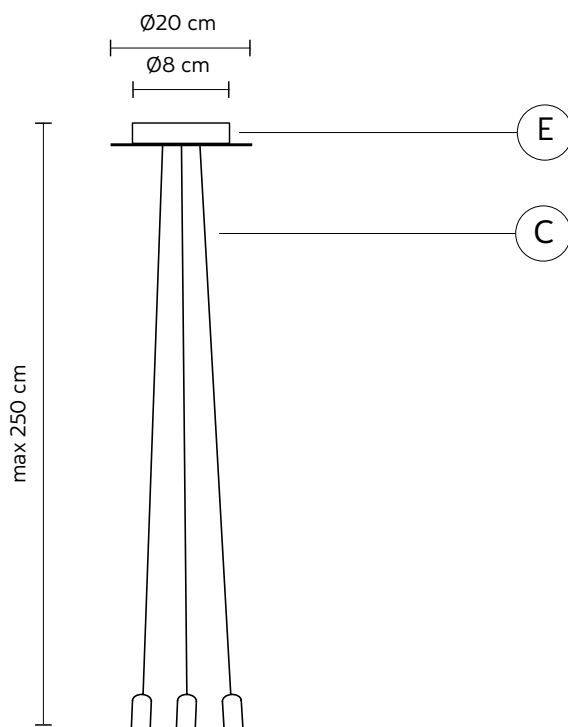

ACCESSORY LAMPSHADES

material glass
colour - transparent
- tiffany



Max 22 lampshades

AC134 2S INT - transparent AC134 2T INT - tiffany

FORMA B

net weight/kg 0,75

SUSPENSION CABLE "F"

material steel

cavo in dotazione MT 4

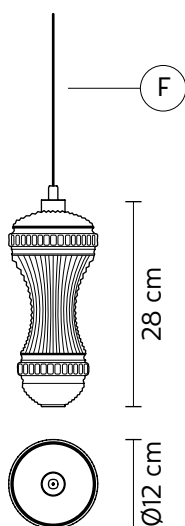

AC134 3S INT - transparent AC134 3T INT - tiffany

FORMA C

net weight/kg 0,25

SUSPENSION CABLE "F"

material steel

cavo in dotazione MT 4

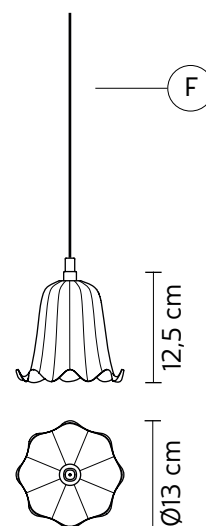

AC134 4S INT - transparent
AC134 4T INT - tiffany

FORMA F

net weight/kg 0,45

SUSPENSION CABLE "F"

material steel

cavo in dotazione MT 4

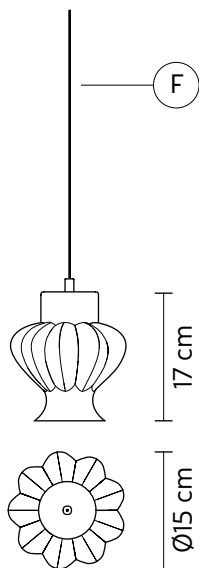

AC134 5S INT - transparent
AC134 5T INT - tiffany

FORMA H

net weight/kg 0,30

SUSPENSION CABLE "F"

material steel

cavo in dotazione MT 4

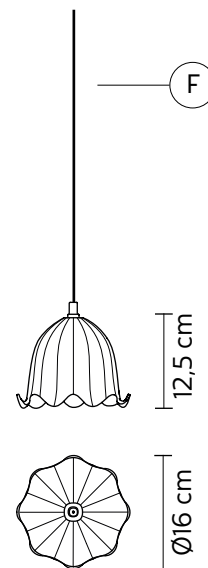

AC134 6S INT - transparent
AC134 6T INT - tiffany

FORMA E

net weight/kg 0,15

SUSPENSION CABLE "F"

material steel

cavo in dotazione MT 4

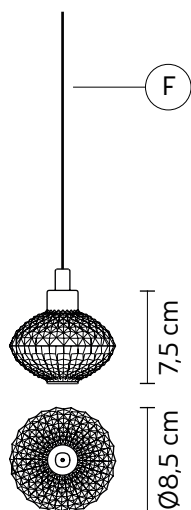

AC134 7S INT - transparent
AC134 7T INT - tiffany

FORMA N

net weight/kg 0,95

SUSPENSION CABLE "F"

material steel

cavo in dotazione MT 4

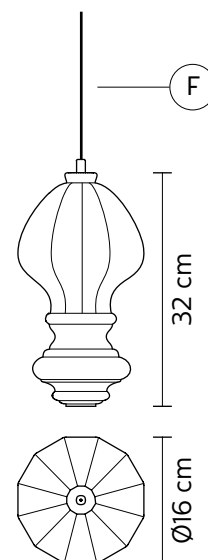

AC135 1S INT - transparent
AC135 1T INT - tiffany

FORMA A

net weight/kg 0,65

SUSPENSION CABLE "F"

material steel

cavo in dotazione MT 4

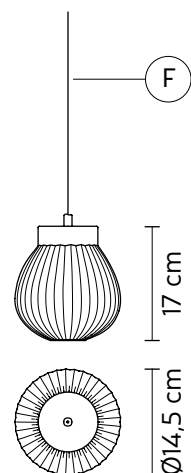

AC135 2S INT - transparent
AC135 2T INT - tiffany

FORMA D

net weight/kg 0,55

SUSPENSION CABLE "F"

material steel

cavo in dotazione MT 4

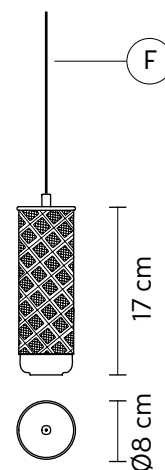

AC135 3S INT - transparent
AC135 3T INT - tiffany

FORMA G

net weight/kg 0,65

SUSPENSION CABLE "F"

material steel

cavo in dotazione MT 4

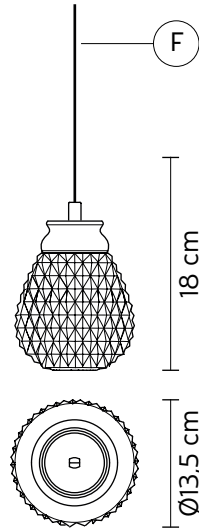

AC135 4S INT - transparent
AC135 4T INT - tiffany

FORMA I

net weight/kg 0,55

SUSPENSION CABLE "F"

material steel

cavo in dotazione MT 4

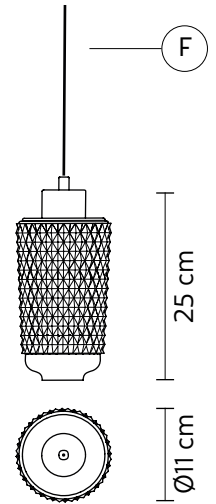

AC135 5S INT - transparent
AC135 5T INT - tiffany

FORMA L

net weight/kg 0,95

SUSPENSION CABLE "F"

material steel

cavo in dotazione MT 4



AC135 6S INT - transparent
AC135 6T INT - tiffany

FORMA M

net weight/kg 0,80

SUSPENSION CABLE "F"

material steel

cavo in dotazione MT 4

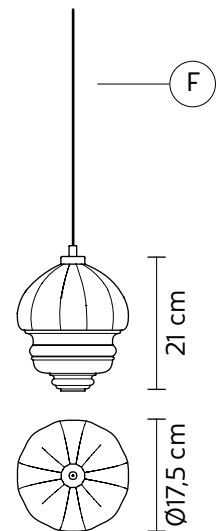

CERAUNAVOLTA suspension lamp

Matteo Ugolini & Edmondo Testaguzza design

year 2018

DATA SHEET - SE135 5T INT

LAMPSHADE "A"

material glass
colour tiffany



CEILING CUP "E"

material metal
colour matt white

ELECTRICAL CABLE "C"

colour transparent



ELECTRICAL SYSTEM

socket G9
source 1 x max 33W
energy class from E to A++

PACKAGING

n° cartons 1
net weight/kg 1,5
gross weight/kg 1,95
packaging/cm 24x24x39

LIGHT EMISSION

unidirectional

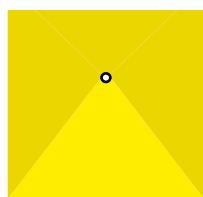

direct
filtered
indirect
absence

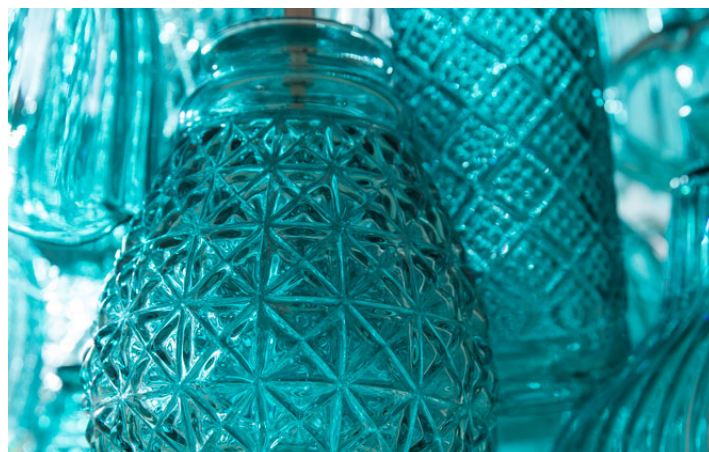
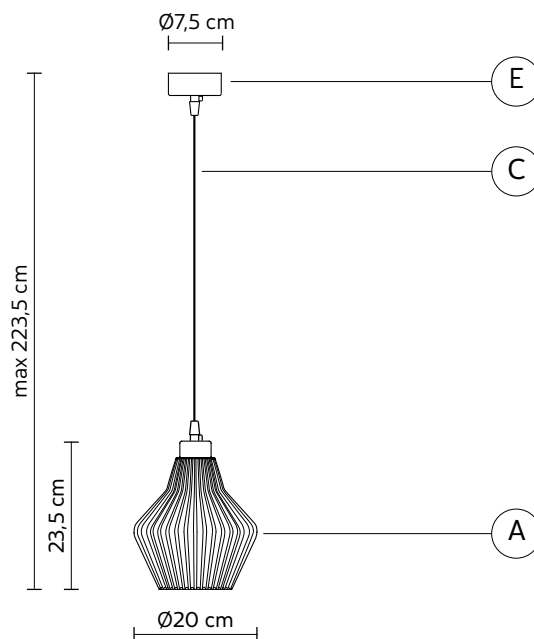

COMPLIANT WITH

IEC 60598-1:2014
EN 60598-1:2015



degree of protection IP20
equipped



1xG9 halogen
33W, 460lumen - 3000K
class D

COLLECTION

available also multiple configuration,
personalized configuration, transparent and tiffany version

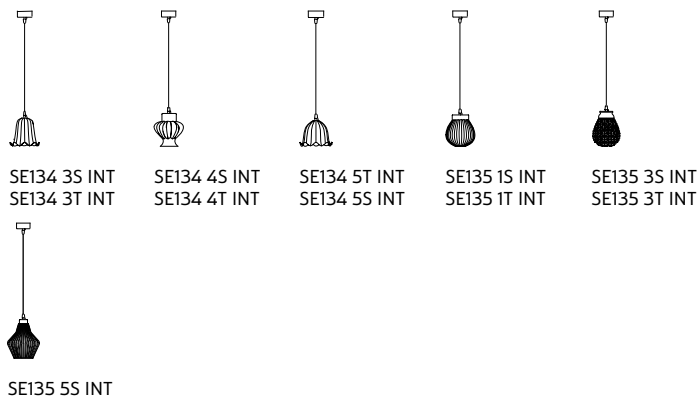

CERAUNAVOLTA suspension lamp

Matteo Ugolini & Edmondo Testaguzza design

year 2018

DATA SHEET - SE135 1T INT

LAMPSHADE "A"

material glass
colour tiffany

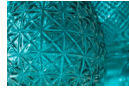

CEILING CUP "E"

material metal
colour matt white

ELECTRICAL CABLE "C"

colour transparent



ELECTRICAL SYSTEM

socket G9
source 1 x max 33W
energy class from E to A++

PACKAGING

n° cartons 1
net weight/kg 1
gross weight/kg 1,65
packaging/cm 24x24x39

LIGHT EMISSION

unidirectional

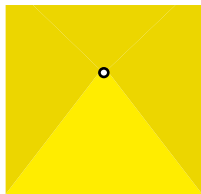

direct
filtered
indirect
absence

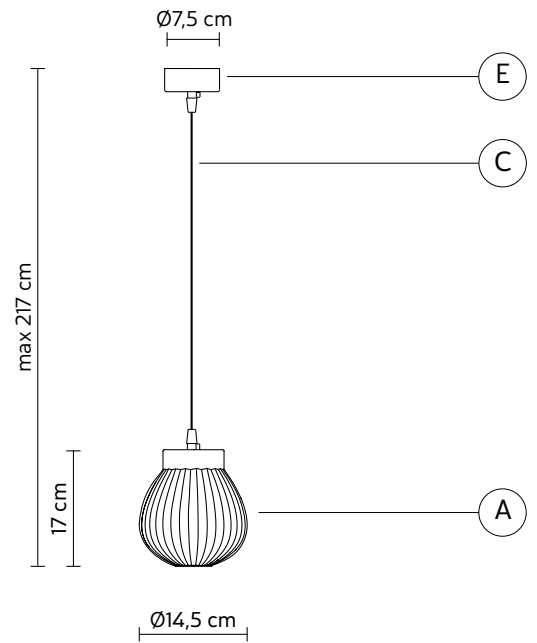

COMPLIANT WITH

IEC 60598-1:2014
EN 60598-1:2015



degree of protection IP20
equipped



1xG9 halogen
33W, 460lumen - 3000K
class D

COLLECTION

available also multiple configuration,
personalized configuration, transparent and tiffany version



SE134 3S INT
SE134 3T INT



SE134 4S INT
SE134 4T INT



SE134 5S INT
SE134 5T INT



SE135 1S INT



SE135 3S INT
SE135 3T INT



SE135 5S INT
SE135 5T INT

CERAUNAVOLTA suspension lamp

Matteo Ugolini & Edmondo Testaguzza design

year 2018

DATA SHEET - SE134 3S INT

LAMPSHADE "A"

material	glass	
colour	transparent	

CEILING CUP "E"

material	metal
colour	matt white

ELECTRICAL CABLE "C"

colour	transparent	
--------	-------------	---

ELECTRICAL SYSTEM

socket	G9
source	1 x max 33W
energy class	from E to A++

PACKAGING

n° cartons	1
net weight/kg	0,75
gross weight/kg	1,4
packaging/cm	24x24x39

LIGHT EMISSION

unidirectional

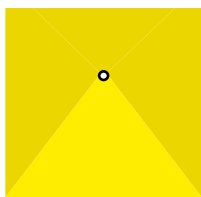

	direct
	filtered
	indirect
	absence

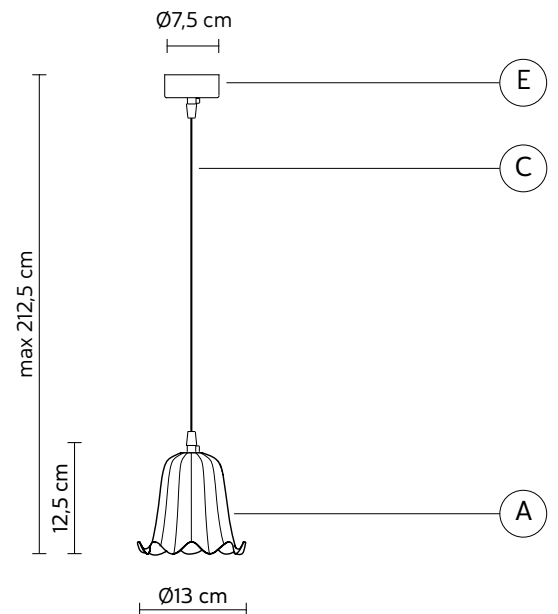

COMPLIANT WITH

IEC	60598-1:2014
EN	60598-1:2015



degree of protection	IP20
bulb	equipped



1xG9 halogen
33W, 460lumen - 3000K
class D



COLLECTION

available also multiple configuration,
personalized configuration, transparent and tiffany version

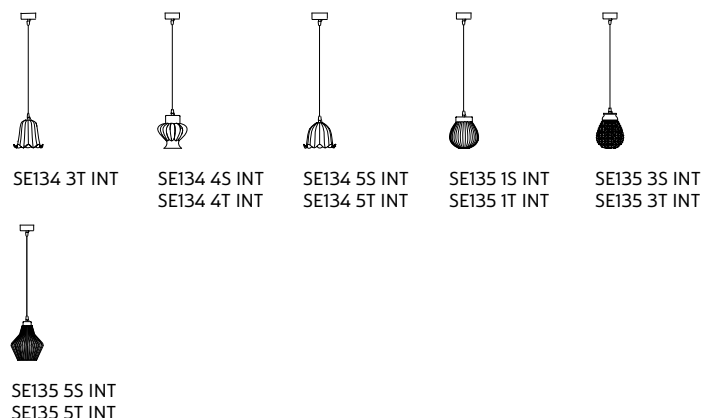

CERAUNAVOLTA suspension lamp

Matteo Ugolini & Edmondo Testaguzza design

year 2018

DATA SHEET - SE135 3T INT

LAMPSHADE "A"

material glass
colour tiffany



CEILING CUP "E"

material metal
colour matt white

ELECTRICAL CABLE "C"

colour transparent



ELECTRICAL SYSTEM

socket G9
source 1 x max 33W
energy class from E to A++

PACKAGING

n° cartons 1
net weight/kg 0,85
gross weight/kg 1,55
packaging/cm 24x24x39

LIGHT EMISSION

unidirectional

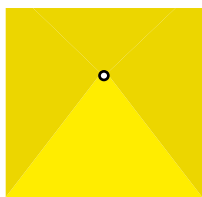

direct
filtered
indirect
absence

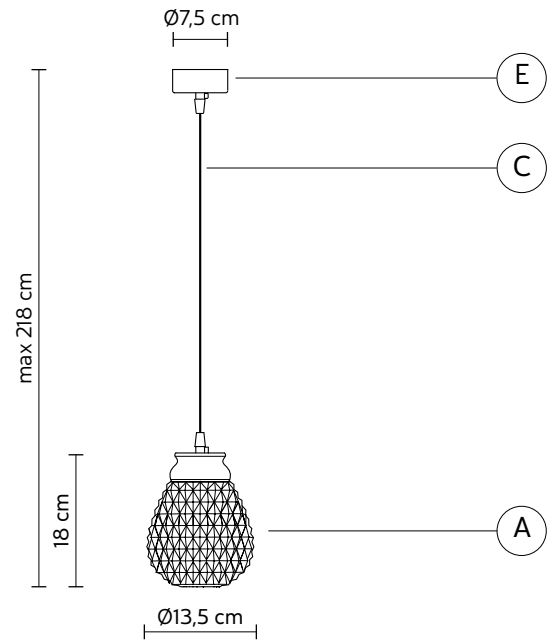

COMPLIANT WITH

IEC 60598-1:2014
EN 60598-1:2015



degree of protection IP20
equipped



1xG9 halogen
33W, 460lumen - 3000K
class D

COLLECTION

available also multiple configuration,
personalized configuration, transparent and tiffany version

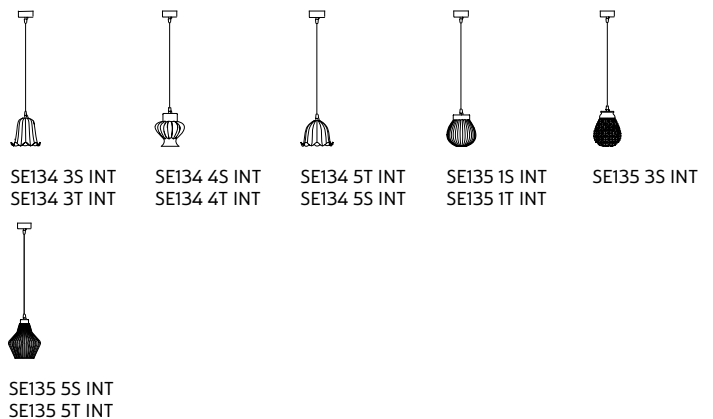

CERAUNAVOLTA suspension lamp

Matteo Ugoluni & Edmondo Testaguzza design

year 2018

DATA SHEET - SE134 5T INT

LAMPSHADE "A"

material glass
colour tiffany



CEILING CUP "E"

material metal
colour matt white

ELECTRICAL CABLE "C"

colour transparent



ELECTRICAL SYSTEM

socket G9
source 1 x max 33W
energy class from E to A++

PACKAGING

n° cartons 1
net weight/kg 0,8
gross weight/kg 1,4
packaging/cm 24x24x39

LIGHT EMISSION

unidirectional

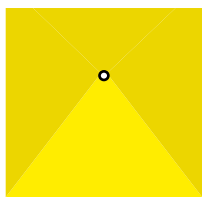

direct
filtered
indirect
absence

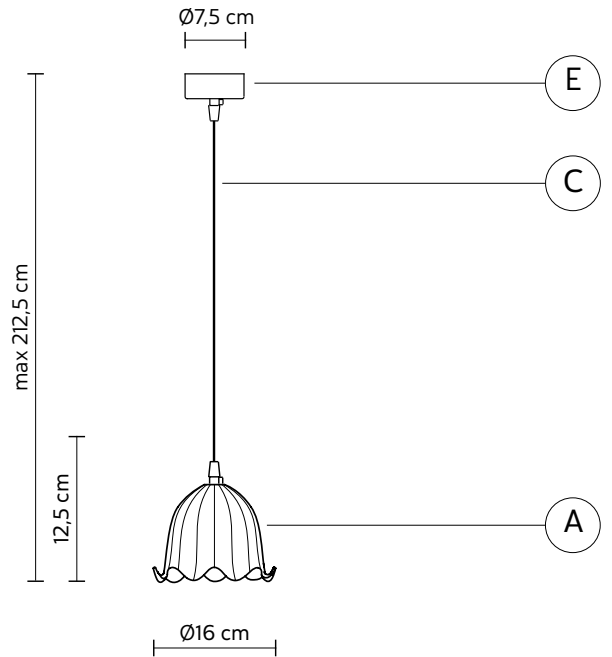

COMPLIANT WITH

IEC 60598-1:2014
EN 60598-1:2015



degree of protection IP20
bulb equipped



1xG9 halogen
33W, 460lumen - 3000K
class D

COLLECTION

available also multiple configuration,
personalized configuration, transparent and tiffany version

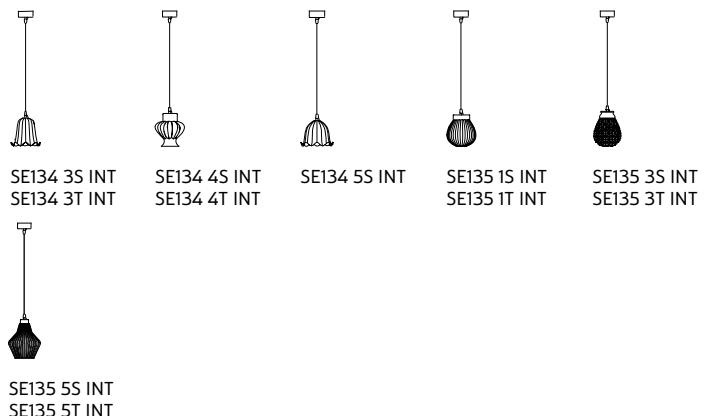

CERAUNAVOLTA suspension lamp

Matteo Ugolini & Edmondo Testaguzza design

year 2018

DATA SHEET - SE134 5S INT

LAMPSHADE "A"

material	glass	
colour	transparent	

CEILING CUP "E"

material	metal
colour	matt white

ELECTRICAL CABLE "C"

colour	transparent	
--------	-------------	---

ELECTRICAL SYSTEM

socket	G9
source	1 x max 33W
energy class	from E to A++



PACKAGING

n° cartons	1
net weight/kg	0,8
gross weight/kg	1,4
packaging/cm	24x24x39

LIGHT EMISSION

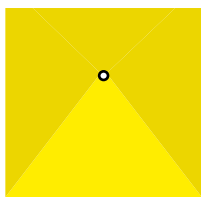
unidirectional



	direct
	filtered
	indirect
	absence

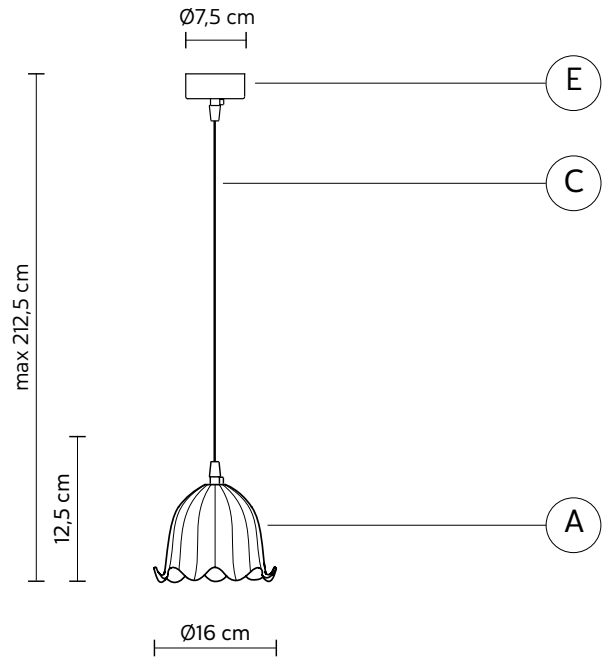

COMPLIANT WITH

IEC 60598-1:2014
EN 60598-1:2015



degree of protection **IP20**
equipped



1xG9 halogen
33W, 460lumen - 3000K
class D

COLLECTION

available also multiple configuration,
personalized configuration, transparent and tiffany version

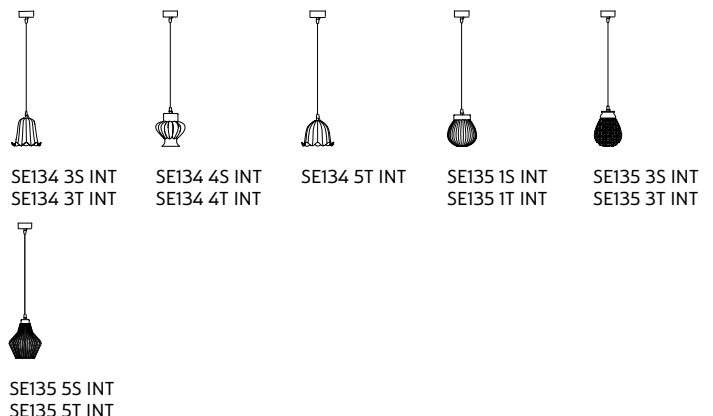

CERAUNAVOLTA suspension lamp

Matteo Ugolini & Edmondo Testaguzza design

year 2018

DATA SHEET - SE134 4T INT

LAMPSHADE "A"

material glass
colour tiffany



CEILING CUP "E"

material metal
colour matt white

ELECTRICAL CABLE "C"

colour transparent



ELECTRICAL SYSTEM

socket G9
source 1 x max 33W
energy class from E to A++

PACKAGING

n° cartons 1
net weight/kg 0,95
gross weight/kg 1,5
packaging/cm 24x24x39

LIGHT EMISSION

unidirectional

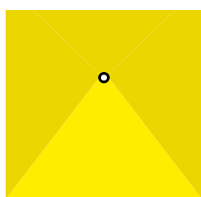

direct
filtered
indirect
absence

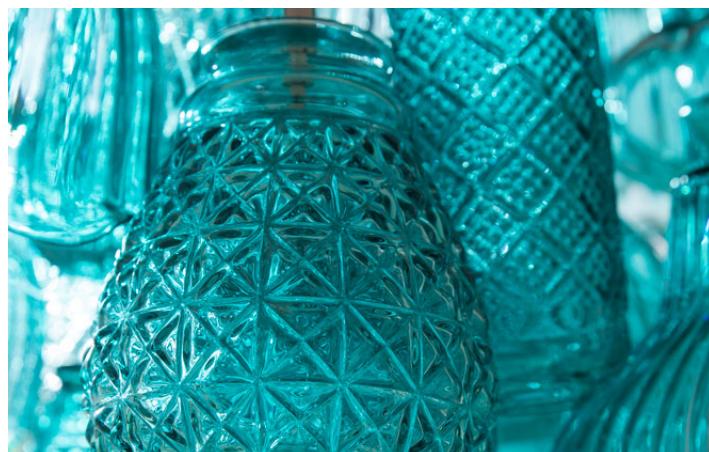
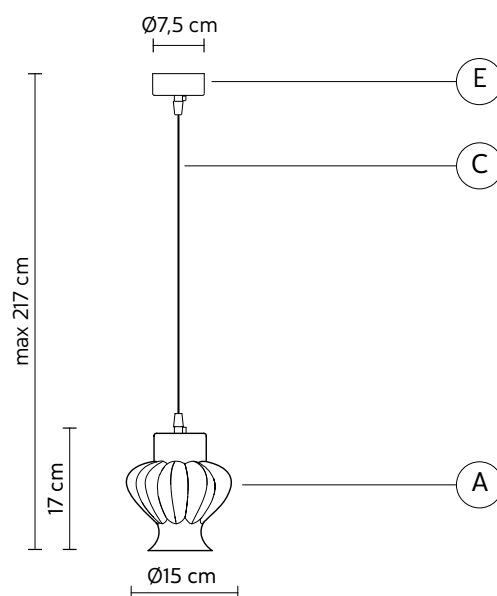

COMPLIANT WITH

IEC 60598-1:2014
EN 60598-1:2015



degree of protection IP20
bulb equipped



1xG9 halogen
33W, 460lumen - 3000K
class D

COLLECTION

available also multiple configuration,
personalized configuration, transparent and tiffany version



SE134 3S INT
SE134 3T INT



SE134 4S INT



SE134 5S INT
SE134 5T INT



SE135 1S INT
SE135 1T INT



SE135 3S INT
SE135 3T INT



SE135 5S INT
SE135 5T INT

CERAUNAVOLTA suspension lamp

Matteo Ugolini & Edmondo Testaguzza design

year 2018

DATA SHEET - SE134 4S INT

LAMPSHADE "A"

material	glass	
colour	transparent	

CEILING CUP "E"

material	metal
colour	matt white

ELECTRICAL CABLE "C"

colour	transparent	
--------	-------------	---

ELECTRICAL SYSTEM

socket	G9
source	1 x max 33W
energy class	from E to A++



PACKAGING

n° cartons	1
net weight/kg	0,95
gross weight/kg	1,5
packaging/cm	24x24x39

LIGHT EMISSION

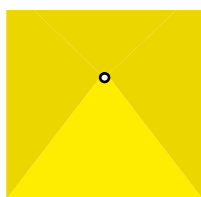
unidirectional



	direct
	filtered
	indirect
	absence

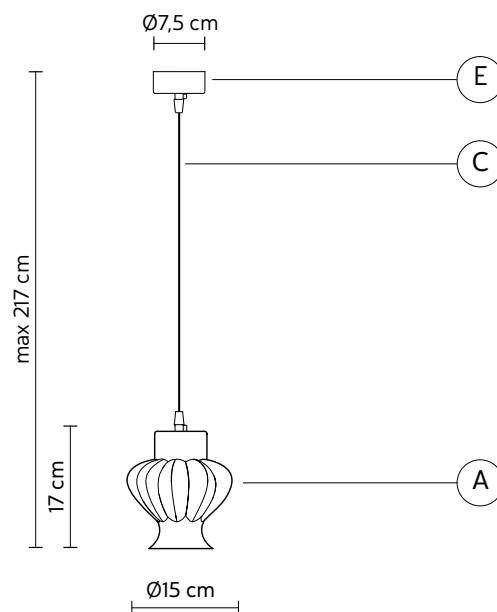

COMPLIANT WITH

IEC	60598-1:2014
EN	60598-1:2015



degree of protection	IP20
bulb	equipped



1xG9 halogen
33W, 460lumen - 3000K
class D

COLLECTION

available also multiple configuration,
personalized configuration, transparent and tiffany version



SE134 3S INT
SE134 3T INT



SE134 4T INT

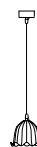

SE134 5S INT
SE134 5T INT



SE135 1S INT
SE135 1T INT



SE135 3S INT
SE135 3T INT



SE135 5S INT
SE135 5T INT

CERAUNAVOLTA suspension lamp

Matteo Ugolini & Edmondo Testaguzza design

year 2018

DATA SHEET - SE134 3T INT

LAMPSHADE "A"

material glass
colour tiffany



CEILING CUP "E"

material metal
colour matt white

ELECTRICAL CABLE "C"

colour transparent



ELECTRICAL SYSTEM

socket G9
source 1 x max 33W
energy class from E to A++

PACKAGING

n° cartons 1
net weight/kg 0,75
gross weight/kg 1,4
packaging/cm 24x24x39

LIGHT EMISSION

unidirectional

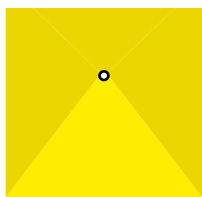

direct
filtered
indirect
absence

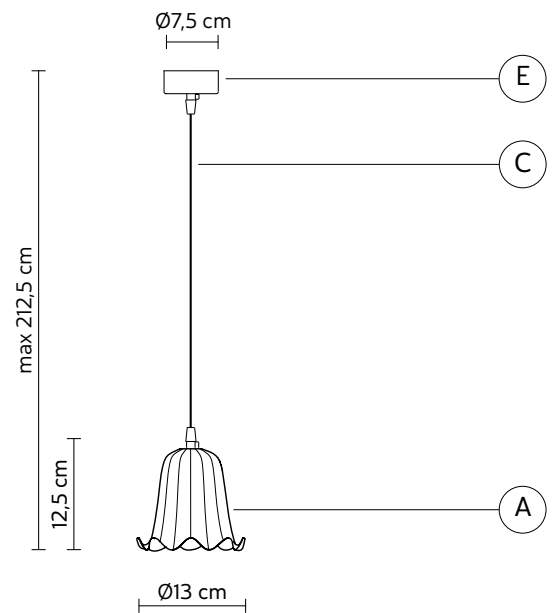

COMPLIANT WITH

IEC 60598-1:2014
EN 60598-1:2015



degree of protection IP20
bulb equipped



1xG9 halogen
33W, 460lumen - 3000K
class D

COLLECTION

available also multiple configuration,
personalized configuration, transparent and tiffany version

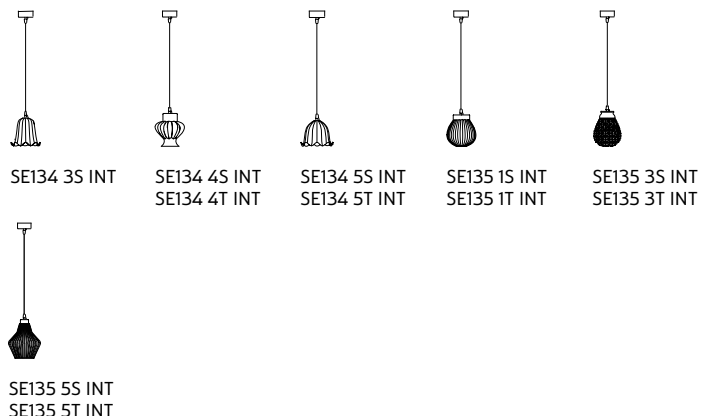

CERAUNAVOLTA suspension lamp

Matteo Ugolini & Edmondo Testaguzza design

year 2018

DATA SHEET - SE134 3S INT

LAMPSHADE "A"

material	glass	
colour	transparent	

CEILING CUP "E"

material	metal
colour	matt white

ELECTRICAL CABLE "C"

colour	transparent	
--------	-------------	---

ELECTRICAL SYSTEM

socket	G9
source	1 x max 33W
energy class	from E to A++



PACKAGING

n° cartons	1
net weight/kg	0,75
gross weight/kg	1,4
packaging/cm	24x24x39

LIGHT EMISSION

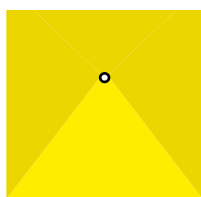
unidirectional



	direct
	filtered
	indirect
	absence

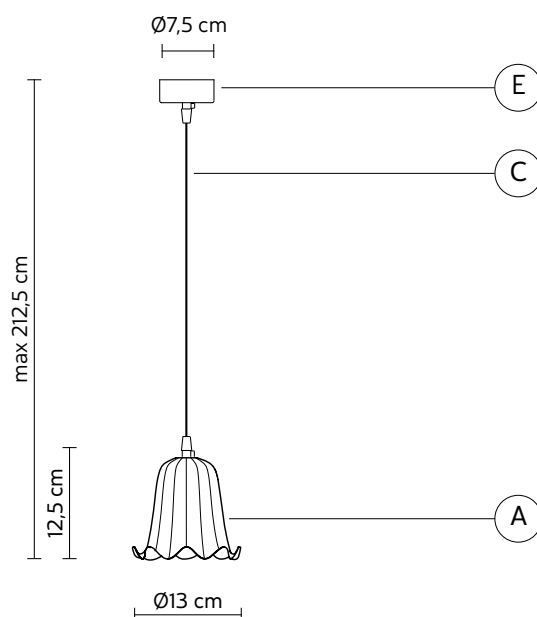

COMPLIANT WITH

IEC	60598-1:2014
EN	60598-1:2015



degree of protection	IP20
bulb	equipped



1xG9 halogen
33W, 460lumen - 3000K
class D



COLLECTION

available also multiple configuration,
personalized configuration, transparent and tiffany version



SE134 3T INT



SE134 4S INT
SE134 4T INT



SE134 5S INT
SE134 5T INT

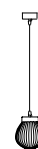

SE135 1S INT
SE135 1T INT



SE135 3S INT
SE135 3T INT



SE135 5S INT
SE135 5T INT

CERAUNAVOLTA suspension lamp

Matteo Ugolini & Edmondo Testaguzza design

year 2018

DATA SHEET - SE134 3S INT

LAMPSHADE "A"

material glass
colour transparent



CEILING CUP "E"

material metal
colour matt white

ELECTRICAL CABLE "C"

colour transparent



ELECTRICAL SYSTEM

socket G9
source 1 x max 33W
energy class from E to A++



PACKAGING

n° cartons 1
net weight/kg 0,75
gross weight/kg 1,4
packaging/cm 24x24x39

LIGHT EMISSION

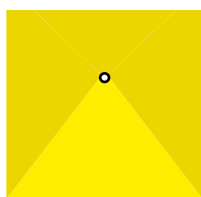
unidirectional



 direct
 filtered
 indirect
 absence

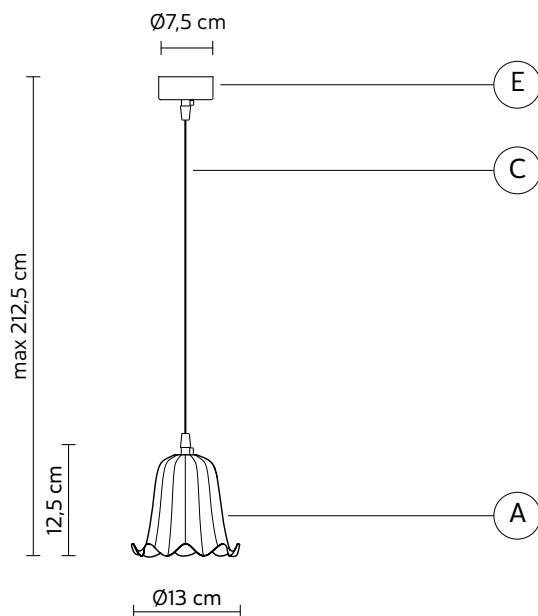

COMPLIANT WITH

IEC 60598-1:2014
EN 60598-1:2015



degree of protection IP20
equipped



1xG9 halogen
33W, 460lumen - 3000K
class D

COLLECTION

available also multiple configuration,
personalized configuration, transparent and tiffany version

