

GINGER suspension

Edmondo Testaguzza design

year 2015

TECHNICAL SHEET - SE116 1A EXT

STRUCTURE "A"

material glass
colour yellow



CEILING CUP "E"

material metal
colour transparent

ELECTRICAL CABLE "C"

material neoprene
colour black



ELECTRICAL SYSTEM

socket E27
source max 1x52w
energy class from E to A++

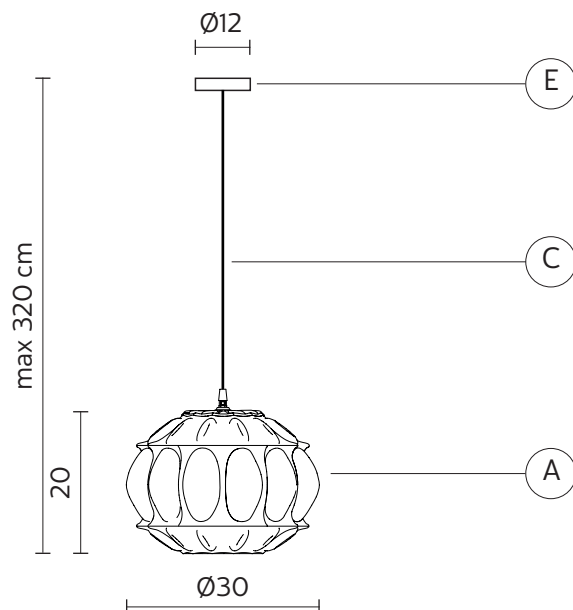





PACKAGING

nr. of collis 1
net weight/kg 2,8
gross weight/kg 4,1
packaging/cm 43x42x32

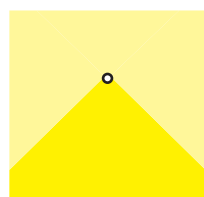
EMISSION OF LIGHT

one-directional



 direct
 filtered
 indirect
 none



CERTIFICATION

IEC 60598-1:2008
EN 60598-1:2008 + A11:2009



IP rate IP44
bulb not provided

COLLECTION



SE1161FINT



SE1161AINT

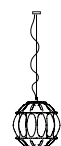

SE1162FINT



SE1162AINT



SE1163FINT

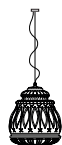

SE1163AINT



SE1161FEXT



SE1162FEXT



SE1162AEXT



SE1163FEXT



SE1163AEXT

GINGER suspension

Edmondo Testaguzza design

year 2015

TECHNICAL SHEET - SE116 1A INT

STRUCTURE "A"

material glass
colour yellow



CEILING CUP "E"

material metal
colour transparent

ELECTRICAL CABLE "C"

material fabric cable
colour black



SUSPENSION CABLE "F"

material steel

ELECTRICAL SYSTEM

socket E27
source max 1x77w
energy class from E to A++



PACKAGING

nr. of collis 1
net weight/kg 2,8
gross weight/kg 4,1
packaging/cm 43x42x32

EMISSION OF LIGHT

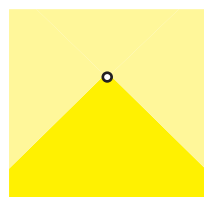
one-directional



 direct
 filtered
 indirect
 none

CERTIFICATION

IEC 60598-1:2008
EN 60598-1:2008 + A11:2009



IP rate IP20
bulb not provided

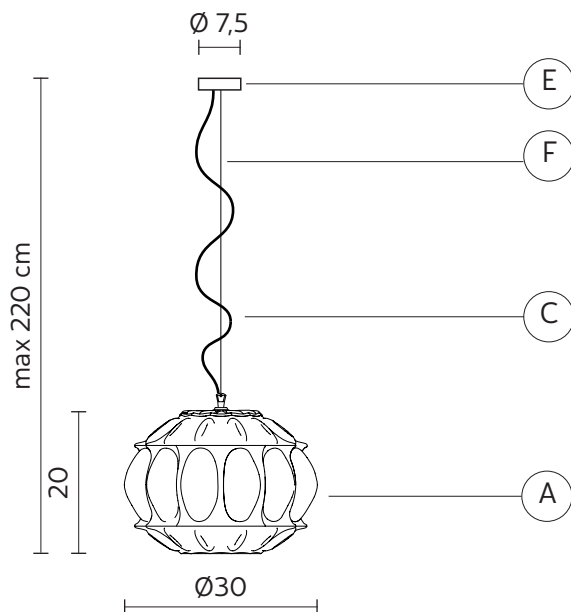

COLLECTION

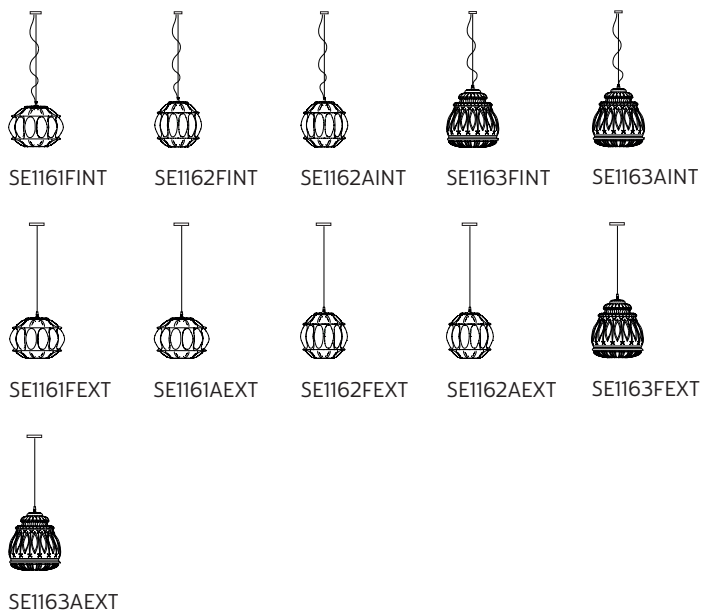

GINGER suspension

Edmondo Testaguzza design

year 2015

TECHNICAL SHEET - SE116 1F EXT

STRUCTURE "A"

material glass
colour smoked



CEILING CUP "E"

material metal
colour transparent

ELECTRICAL CABLE "C"

material neoprene
colour black



ELECTRICAL SYSTEM

socket E27
source max 1x52w
energy class from E to A++

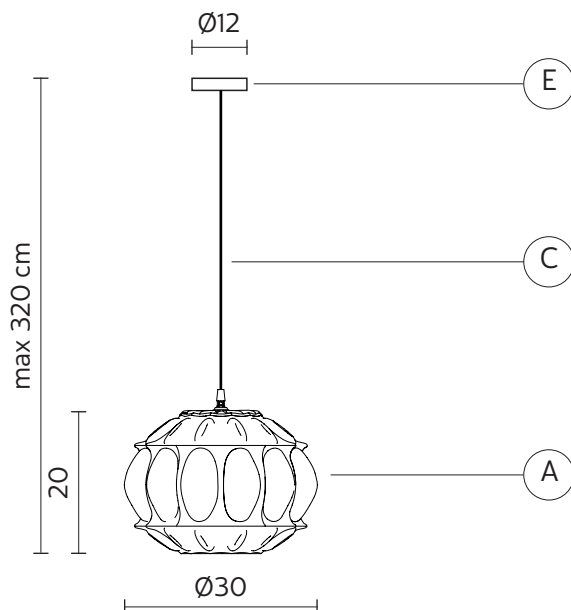





PACKAGING

nr. of collis 1
net weight/kg 2,8
gross weight/kg 4,1
packaging/cm 43x42x32

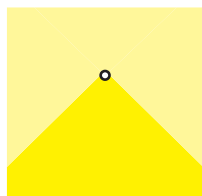
EMISSION OF LIGHT

one-directional



 direct
 filtered
 indirect
 none



CERTIFICATION

IEC 60598-1:2008
EN 60598-1:2008 + A11:2009



IP rate IP44
bulb not provided

COLLECTION

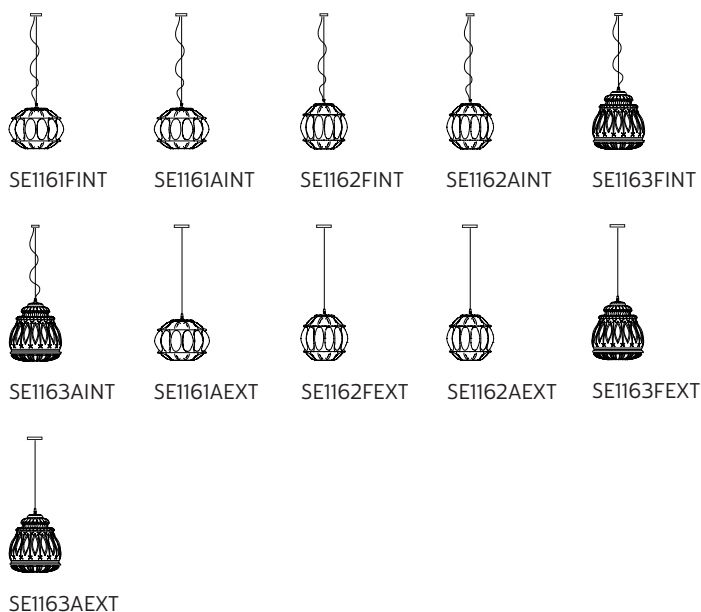

GINGER suspension

Edmondo Testaguzza design

year 2015

TECHNICAL SHEET - SE116 2F EXT

STRUCTURE "A"

material	glass	
colour	smoked	

CEILING CUP "E"

material	metal
colour	transparent

ELECTRICAL CABLE "C"

material	neoprene	
colour	black	

ELECTRICAL SYSTEM

socket	E27
source	max 1x52w
energy class	from E to A++

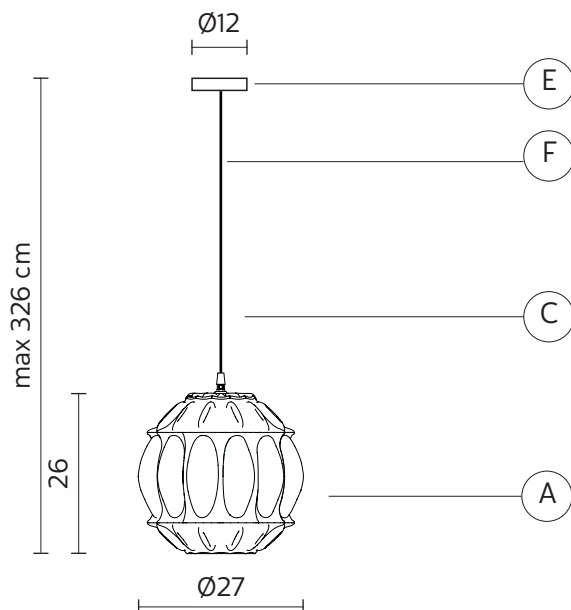

PACKAGING

nr. of collis	1
net weight/kg	2,9
gross weight/kg	4,2
packaging/cm	38x38x42

EMISSION OF LIGHT

one-directional



CERTIFICATION

IEC	60598-1:2008
EN	60598-1:2008 + A11:2009



IP rate	IP44
bulb	not provided

COLLECTION

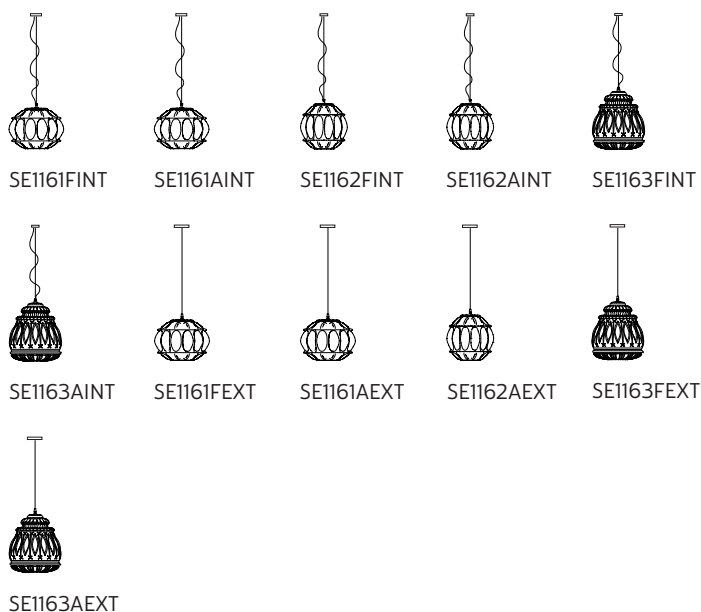

GINGER suspension

Edmondo Testaguzza design

year 2015

TECHNICAL SHEET - SE116 2F INT

STRUCTURE "A"

material glass
colour smoked

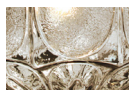

CEILING CUP "E"

material metal
colour transparent

ELECTRICAL CABLE "C"

material fabric cable
colour black



SUSPENSION CABLE "F"

material steel

ELECTRICAL SYSTEM

socket E27
source max 1x77w
energy class from E to A++



PACKAGING

nr. of collis 1
net weight/kg 2,9
gross weight/kg 4,2
packaging/cm 38x38x42

EMISSION OF LIGHT

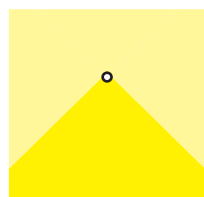
one-directional



 direct
 filtered
 indirect
 none

CERTIFICATION

IEC 60598-1:2008
EN 60598-1:2008 + A11:2009



IP rate IP20
bulb not provided

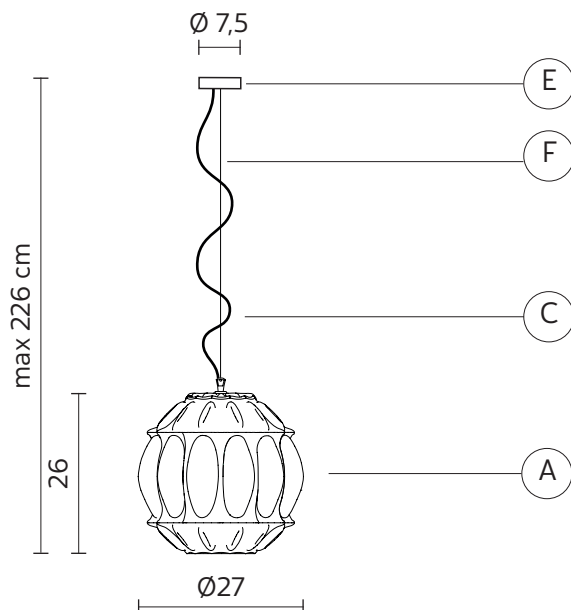

COLLECTION

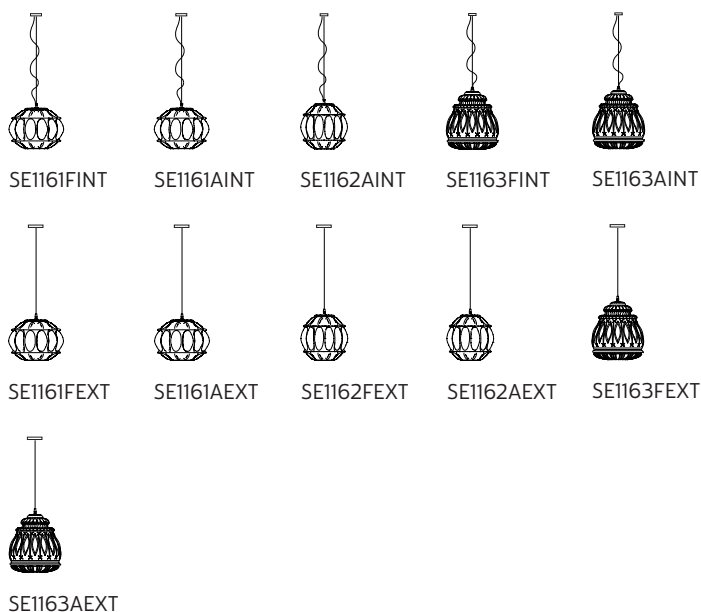

GINGER suspension

Edmondo Testaguzza design

year 2015

TECHNICAL SHEET - SE116 3A EXT

STRUCTURE "A"

material glass
colour yellow



CEILING CUP "E"

material metal
colour transparent

ELECTRICAL CABLE "C"

material neoprene
colour black



ELECTRICAL SYSTEM

socket E27
source max 1x52w
energy class from E to A++

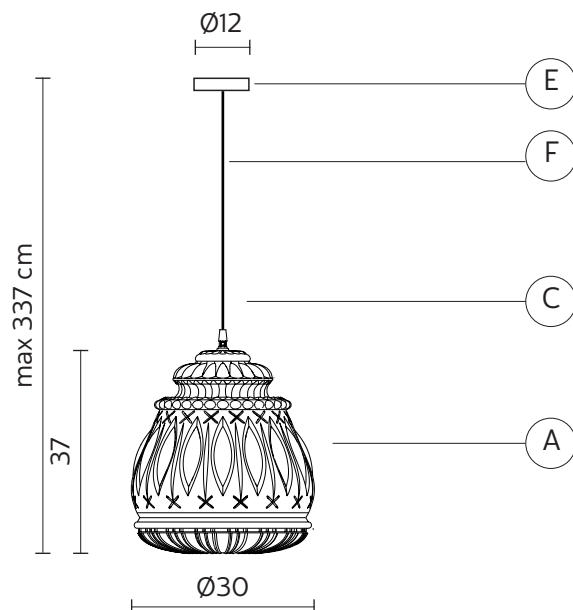





PACKAGING

nr. of collis 1
net weight/kg 5
gross weight/kg 9
packaging/cm 47x47x47

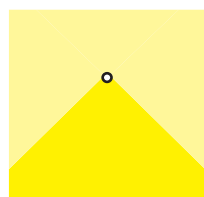
EMISSION OF LIGHT

one-directional



 direct
 filtered
 indirect
 none



CERTIFICATION

IEC 60598-1:2008
EN 60598-1:2008 + A11:2009



IP rate IP44
bulb not provided

COLLECTION

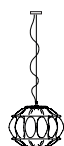

SE1161FINT

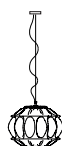

SE1161AINT

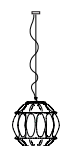

SE1162FINT

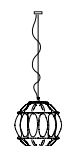

SE1162AINT



SE1163FINT

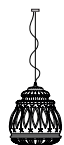

SE1163AINT



SE1161FEXT



SE1161AEXT



SE1162AEXT



SE1162FEXT



SE1163FEXT

GINGER suspension

Edmondo Testaguzza design

anno 2015

TECHNICAL SHEET - SE116 4A EXT

STRUCTURE "A"

material glass
colour yellow



CEILING CUP "E"

material metal
colour matt black

ELECTRICAL CABLE "C"

material neoprene
colour black



ELECTRICAL SYSTEM

socket E27
source max 1x52w
energy class from E to A++

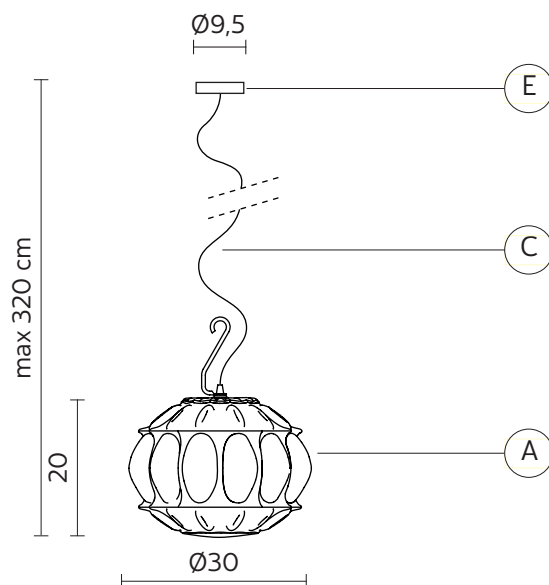

PACKAGING

nr. of collis 1
net weight/kg 2,8
gross weight/kg 4,1
packaging/cm 43x42x32

EMISSION OF LIGHT

one-directional

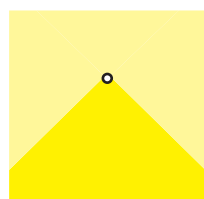

direct
filtered
indirect
none



CERTIFICATION

IEC 60598-1:2008
EN 60598-1:2008 + A11:2009



IP rate IP44
bulb not provided

COLLEZIONE



SE1164FEXT



SE1165AEXT



SE1165FEXT



SE1166FEXT



SE1166AEXT

GINGER suspension

Edmondo Testaguzza design

anno 2015

TECHNICAL SHEET - SE116 4F EXT

STRUCTURE "A"

material glass
colour smoked



CEILING CUP "E"

material metal
colour matt black

ELECTRICAL CABLE "C"

material neoprene
colour black



ELECTRICAL SYSTEM

socket E27
source max 1x52w
energy class from E to A++

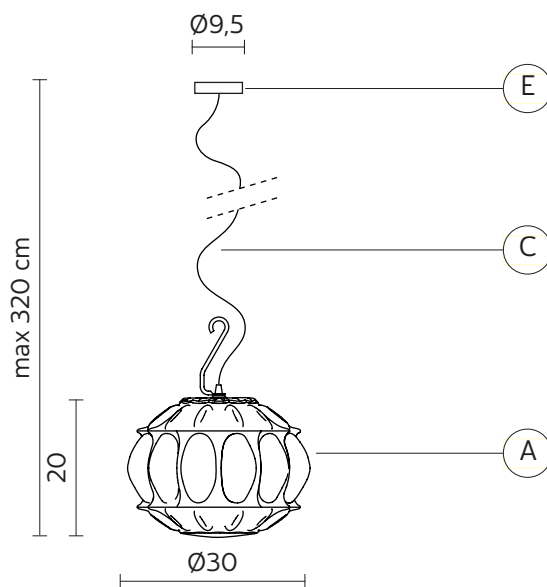

PACKAGING

nr. of collis 1
net weight/kg 2,8
gross weight/kg 4,1
packaging/cm 43x42x32

EMISSION OF LIGHT

one-directional

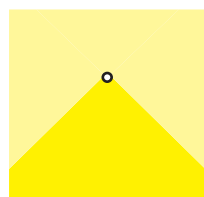

direct
 filtered
 indirect
 none



CERTIFICATION

IEC 60598-1:2008
EN 60598-1:2008 + A11:2009



IP rate IP44
bulb not provided

COLLEZIONE



SE1164AEXT



SE1165AEXT



SE1165FEXT



SE1166FEXT



SE1166AEXT

GINGER suspension

Edmondo Testaguzza design

anno 2015

TECHNICAL SHEET - SE116 5A EXT

STRUCTURE "A"

material glass
colour yellow



CEILING CUP "E"

material metal
colour matt black

ELECTRICAL CABLE "C"

material neoprene
colour black



ELECTRICAL SYSTEM

socket E27
source max 1x52w
energy class from E to A++

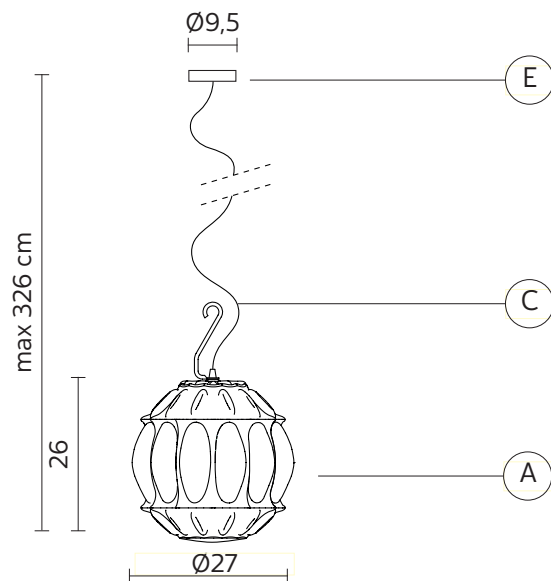

PACKAGING

nr. of collis 1
net weight/kg 2,9
gross weight/kg 4,2
packaging/cm 38x38x42

EMISSION OF LIGHT

one-directional

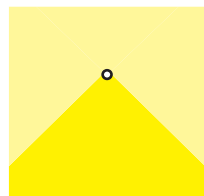

direct
filtered
indirect
none



CERTIFICATION

IEC 60598-1:2008
EN 60598-1:2008 + A11:2009



IP rate IP44
bulb not provided

COLLEZIONE



SE1164FEXT



SE1164AEXT



SE1165FEXT



SE1166FEXT



SE1166AEXT

GINGER suspension

Edmondo Testaguzza design

year 2015

TECHNICAL SHEET - SE116 1F INT

STRUCTURE "A"

material glass
colour smoked



CEILING CUP "E"

material metal
colour transparent

ELECTRICAL CABLE "C"

material fabric cable
colour black



SUSPENSION CABLE "F"

material steel

ELECTRICAL SYSTEM

socket E27
source max 1x77w
energy class from E to A++

PACKAGING

nr. of collis 1
net weight/kg 2,8
gross weight/kg 4,1
packaging/cm 43x42x32

EMISSION OF LIGHT

one-directional

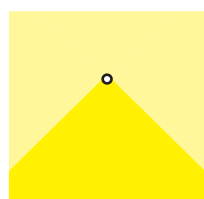

direct
 filtered
 indirect
 none

CERTIFICATION

IEC 60598-1:2008
EN 60598-1:2008 + A11:2009



IP rate IP20
bulb not provided

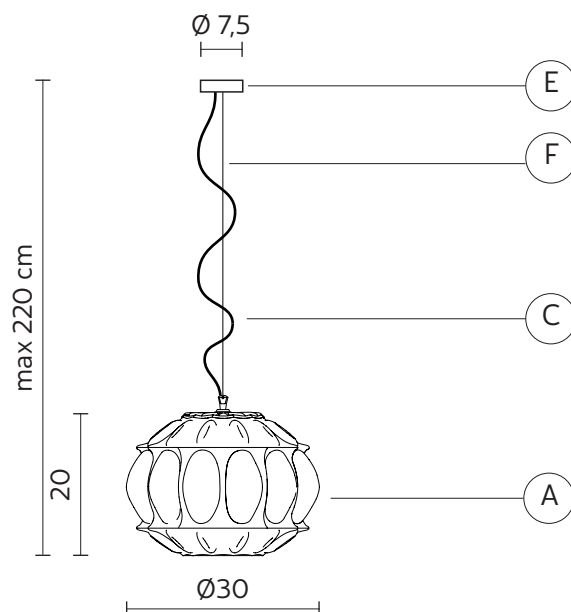

COLLECTION

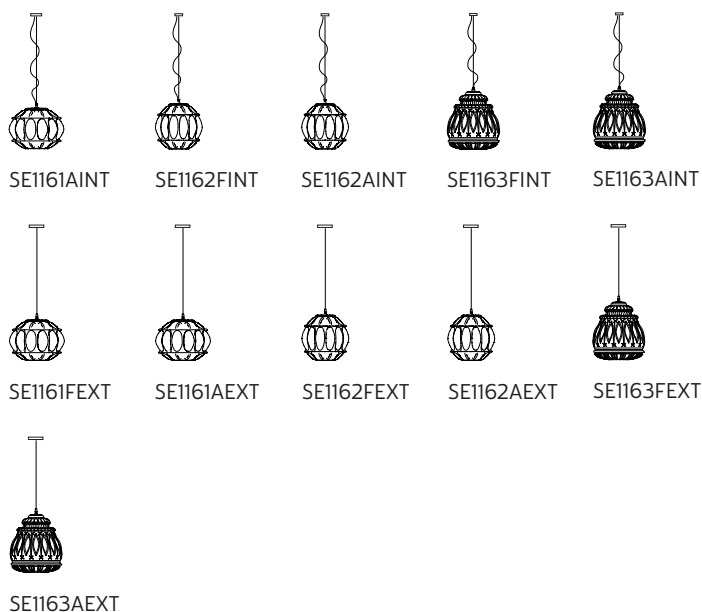

GINGER suspension

Edmondo Testaguzza design

year 2015

TECHNICAL SHEET - SE116 2A EXT

STRUCTURE "A"

material glass
colour yellow



CEILING CUP "E"

material metal
colour transparent

ELECTRICAL CABLE "C"

material neoprene
colour black



ELECTRICAL SYSTEM

socket E27
source max 1x52w
energy class from E to A++

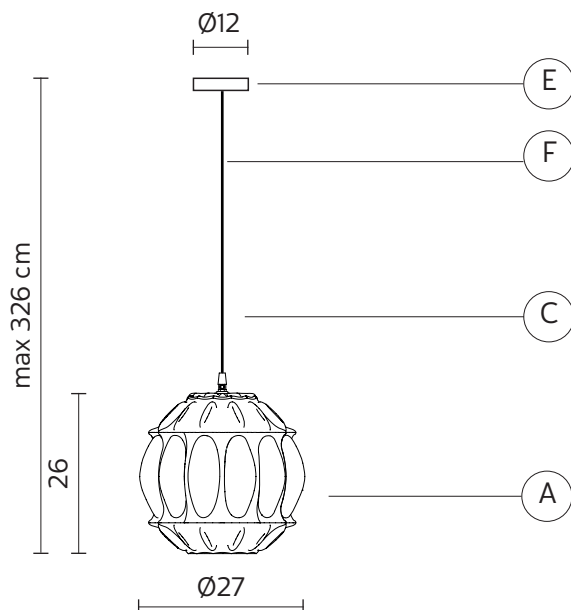

PACKAGING

nr. of collis 1
net weight/kg 2,9
gross weight/kg 4,2
packaging/cm 38x38x42

EMISSION OF LIGHT

one-directional

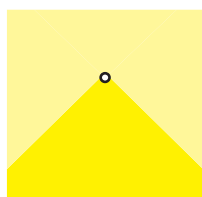

direct
 filtered
 indirect
 none



CERTIFICATION

IEC 60598-1:2008
EN 60598-1:2008 + A11:2009



IP rate IP44
bulb not provided

COLLECTION

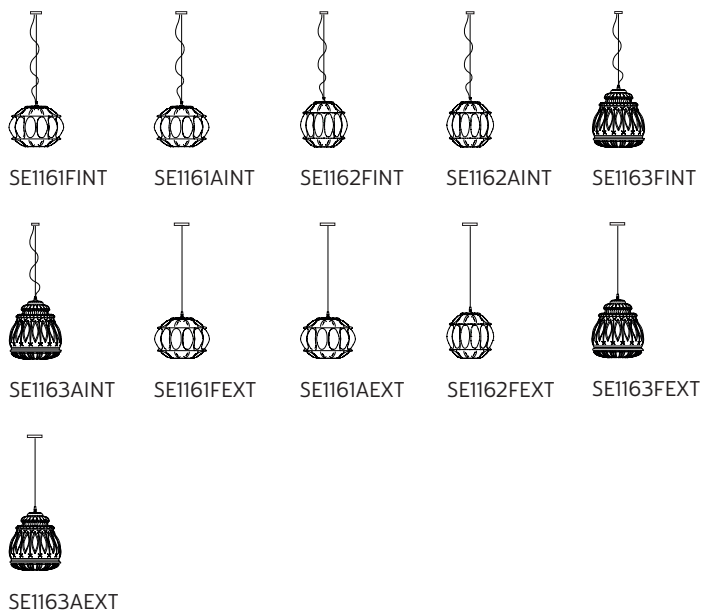

GINGER suspension

Edmondo Testaguzza design

year 2015

TECHNICAL SHEET - SE116 2A INT

STRUCTURE "A"

material glass
colour yellow



CEILING CUP "E"

material metal
colour transparent

ELECTRICAL CABLE "C"

material fabric cable
colour black



SUSPENSION CABLE "F"

material steel

ELECTRICAL SYSTEM

socket E27
source max 1x77w
energy class from E to A++



PACKAGING

nr. of collis 1
net weight/kg 2,9
gross weight/kg 4,2
packaging/cm 38x38x42

EMISSION OF LIGHT

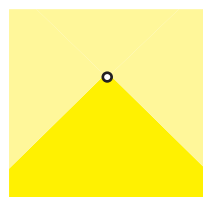
one-directional



 direct
 filtered
 indirect
 none

CERTIFICATION

IEC 60598-1:2008
EN 60598-1:2008 + A11:2009



IP rate IP20
bulb not provided

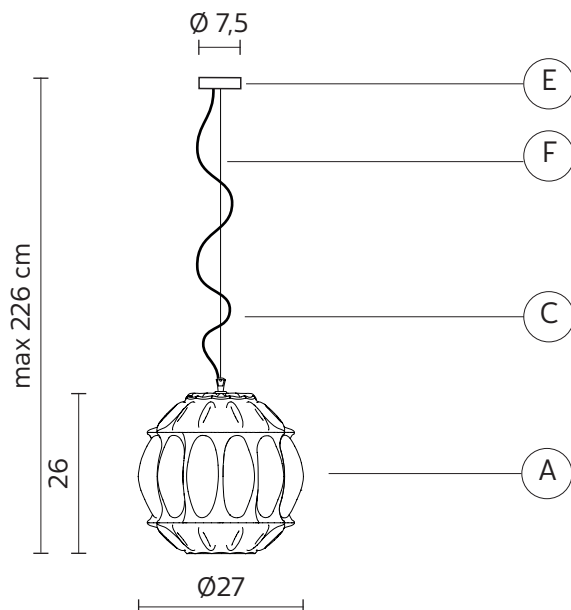

COLLECTION



SE1161FINT



SE1161AINT

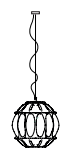

SE1162FINT



SE1163FINT



SE1163AINT



SE1161FEXT



SE1161AEXT



SE1162FEXT



SE1162AEXT



SE1163FEXT



SE1163AEXT

GINGER suspension

Edmondo Testaguzza design

year 2015

TECHNICAL SHEET - SE116 3A INT

STRUCTURE "A"

material glass
colour yellow



CEILING CUP "E"

material metal
colour transparent

ELECTRICAL CABLE "C"

material fabric cable
colour black



SUSPENSION CABLE "F"

material steel

ELECTRICAL SYSTEM

socket E27
source max 1x77w
energy class from E to A++



PACKAGING

nr. of collis 1
net weight/kg 5
gross weight/kg 9
packaging/cm 47x47x47

EMISSION OF LIGHT

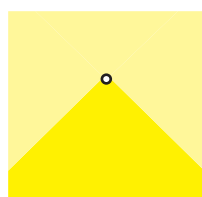
one-directional



 direct
 filtered
 indirect
 none

CERTIFICATION

IEC 60598-1:2008
EN 60598-1:2008 + A11:2009



IP rate IP20
bulb not provided

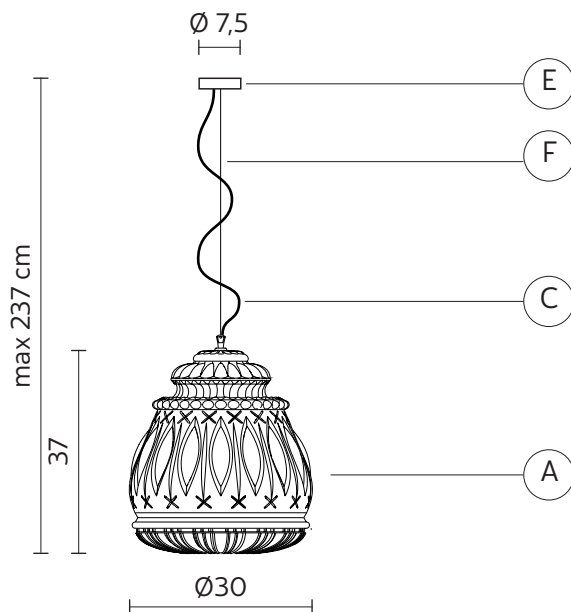

COLLECTION

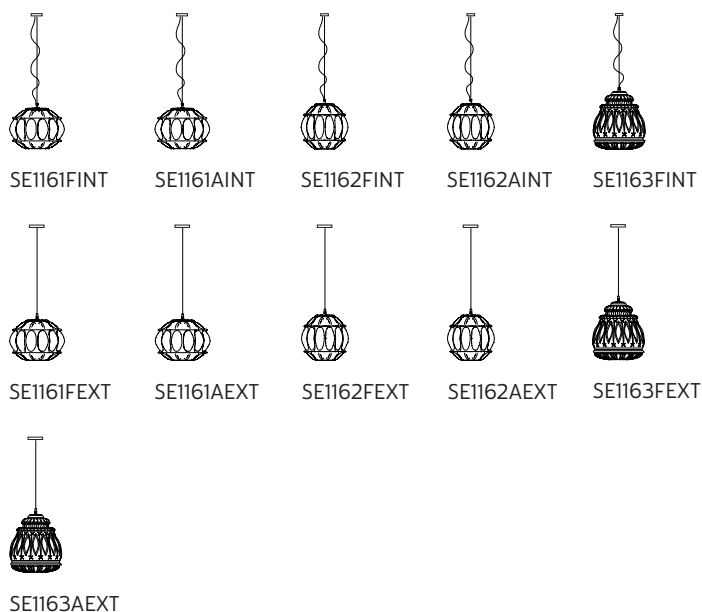

GINGER suspension

Edmondo Testaguzza design

year 2015

TECHNICAL SHEET - SE116 3F EXT

STRUCTURE "A"

material glass
colour smoked



CEILING CUP "E"

material metal
colour matt black

ELECTRICAL CABLE "C"

material neoprene
colour black



ELECTRICAL SYSTEM

socket E27
source max 1x52w
energy class from E to A++

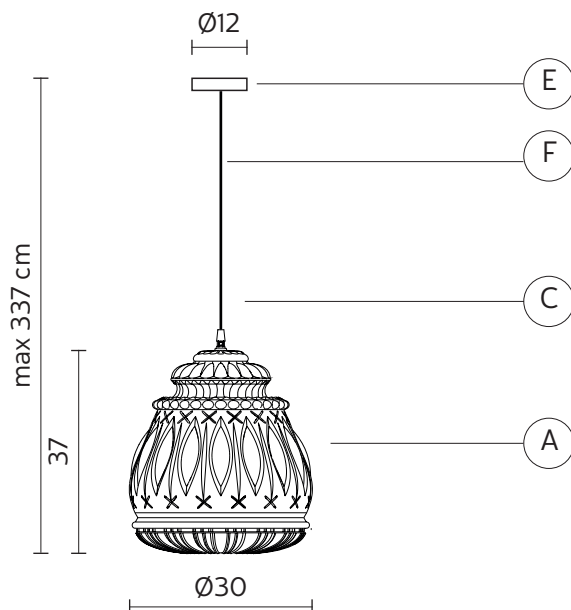





PACKAGING

nr. of collis 1
net weight/kg 5
gross weight/kg 9
packaging/cm 47x47x47

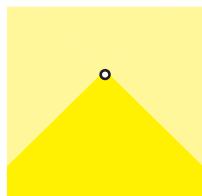
EMISSION OF LIGHT

one-directional



 direct
 filtered
 indirect
 none



CERTIFICATION

IEC 60598-1:2008
EN 60598-1:2008 + A11:2009



IP rate IP44
bulb not provided

COLLECTION

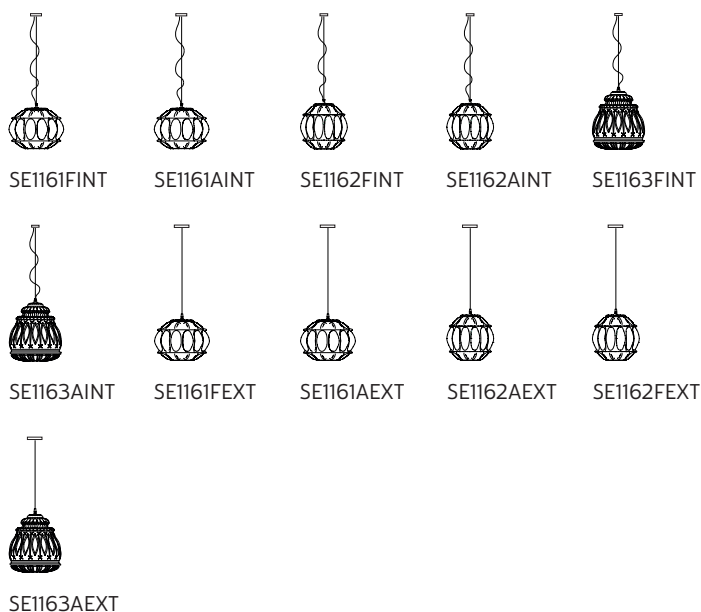

GINGER suspension

Edmondo Testaguzza design

year 2015

TECHNICAL SHEET - SE116 3F INT

STRUCTURE "A"

material glass
colour smoked

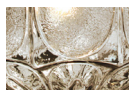

CEILING CUP "E"

material metal
colour transparent

ELECTRICAL CABLE "C"

material fabric cable
colour black



SUSPENSION CABLE "F"

material steel

ELECTRICAL SYSTEM

socket E27
source max 1x77w
energy class from E to A++

PACKAGING

nr. of collis 1
net weight/kg 5
gross weight/kg 9
packaging/cm 47x47x47

EMISSION OF LIGHT

one-directional

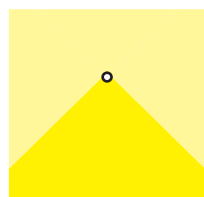

direct
 filtered
 indirect
 none

CERTIFICATION

IEC 60598-1:2008
EN 60598-1:2008 + A11:2009



IP rate IP20
bulb not provided

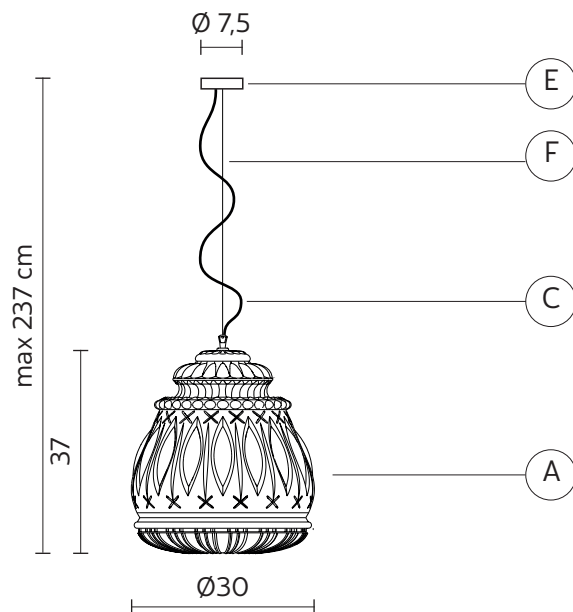

COLLECTION

