

# BLACK OUT floor lamp

Matteo Ugolini design

year 2015

## TECHNICAL SHEET - HP101 2B EXT

### STRUCTURE "A"

material	metal	
colour	matt white	

### SHADE "B"

material	fiberglass	
colour	white	

### ELECTRICAL CABLE "C"

material	neoprene	
colour	green	

### ELECTRICAL SYSTEM

socket	E27
source	max 1x28w
energy class	from E to A++

### PACKAGING

nr. of collis	1
net weight/kg	4,9
gross weight/kg	8,2
packaging/cm	62x62x187

### EMISSION OF LIGHT

one-directional

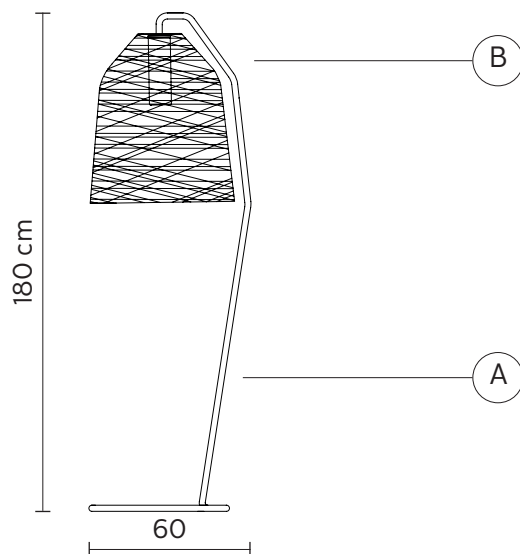

### CERTIFICATION

IEC	60598-1:2008
EN	60598-1:2008 + A11:2009



IP rate	IP 65
bulb	not provided

### COLLECTION

available also as: suspension (in/outdoor)

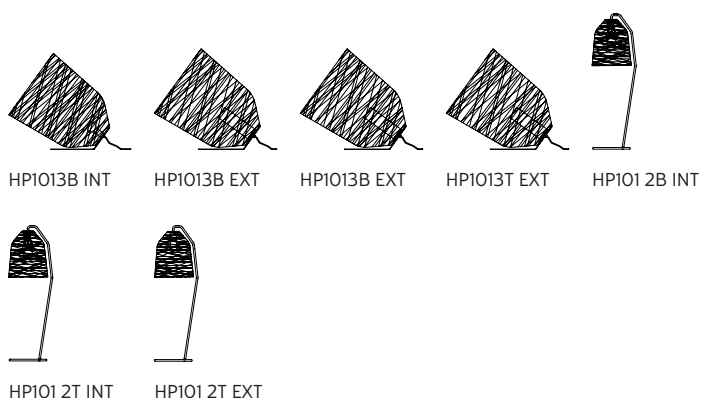

# BLACK OUT floor lamp

Matteo Ugolini design

year 2015

## TECHNICAL SHEET - HP101 2B INT

### STRUCTURE "A"

material	metal	
colour	matt white	

### SHADE "B"

material	fiberglass	
colour	white	

### ELECTRICAL CABLE "C"

material	PVC	
colour	transparent	

### ELECTRICAL SYSTEM

socket	E27
source	max 3x52w
energy class	from E to A++





### PACKAGING

nr. of collis	1
net weight/kg	4,9
gross weight/kg	8,2
packaging/cm	62x62x187

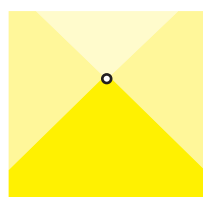
### EMISSION OF LIGHT

one-directional



	direct
	filtered
	indirect
	none

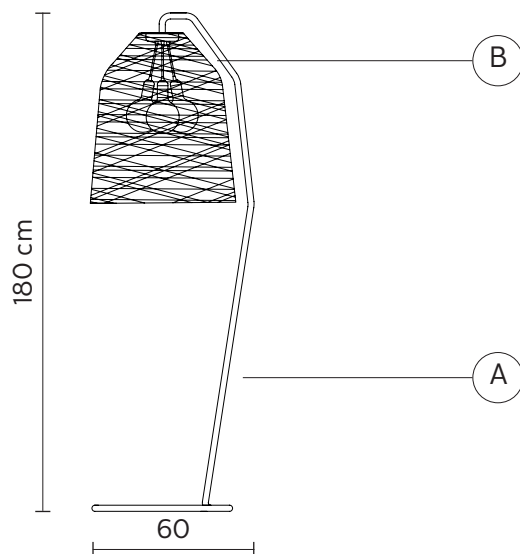

### CERTIFICATION

IEC	60598-1:2008
EN	60598-1:2008 + A11:2009



IP rate	IP20
bulb	not provided

### COLLECTION

available also as: suspension (indoor e outdoor)

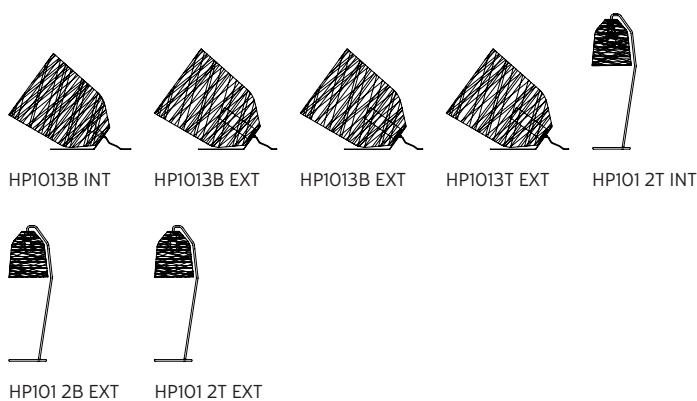

# BLACK OUT floor lamp

Matteo Ugolini design

year 2015

## TECHNICAL SHEET - HP101 2TEXT

### STRUCTURE "A"

material	metal	
colour	matt white	

### SHADE "B"

material	fiberglass	
colour	transparent	

### ELECTRICAL CABLE "C"

material	neoprene	
colour	green	

### ELECTRICAL SYSTEM

socket	E27
source	max 1x28w
energy class	from E to A++





### PACKAGING

nr. of collis	1
net weight/kg	4,9
gross weight/kg	8,2
packaging/cm	62x62x187

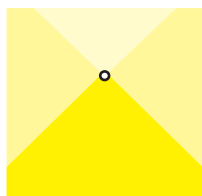
### EMISSION OF LIGHT

one-directional



	direct
	filtered
	indirect
	none

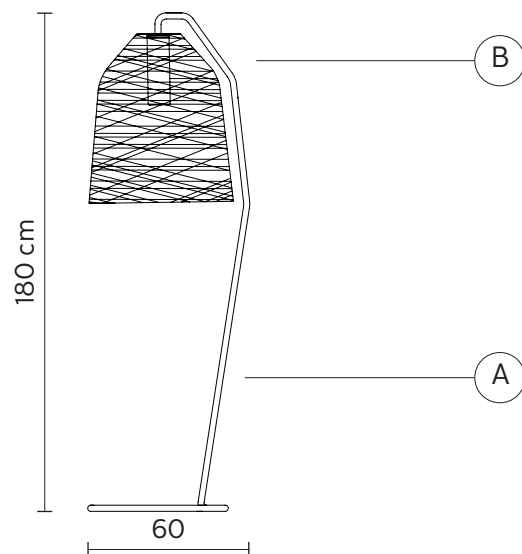

### CERTIFICATION

IEC	60598-1:2008
EN	60598-1:2008 + A11:2009



IP rate	IP 65
bulb	not provided

### COLLECTION

available also as: suspension (in/outdoor)

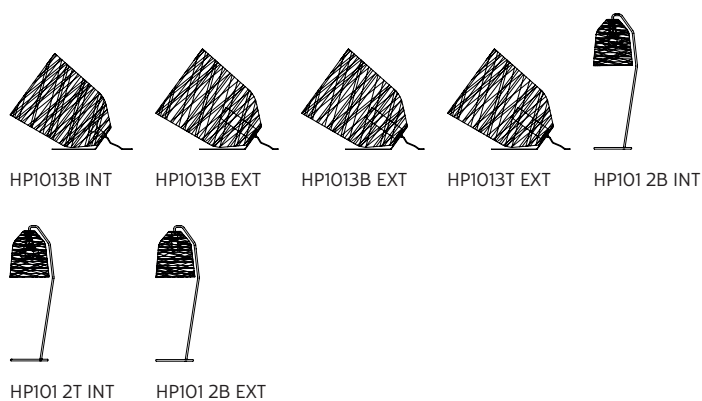

# BLACK OUT floor lamp

Matteo Ugolini design

year 2015

## TECHNICAL SHEET - HP101 2T INT

### STRUCTURE "A"

material	metal	
colour	matt white	

### SHADE "B"

material	fiberglass	
colour	transparent	

### ELECTRICAL CABLE "C"

material	PVC	
colour	transparent	

### ELECTRICAL SYSTEM

socket	E27
source	max 3x52w
energy class	from E to A++





### PACKAGING

nr. of collis	1
net weight/kg	4,9
gross weight/kg	8,2
packaging/cm	62x62x187

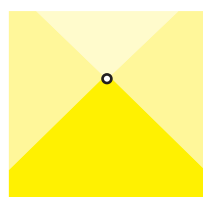
### EMISSION OF LIGHT

one-directional



	direct
	filtered
	indirect
	none

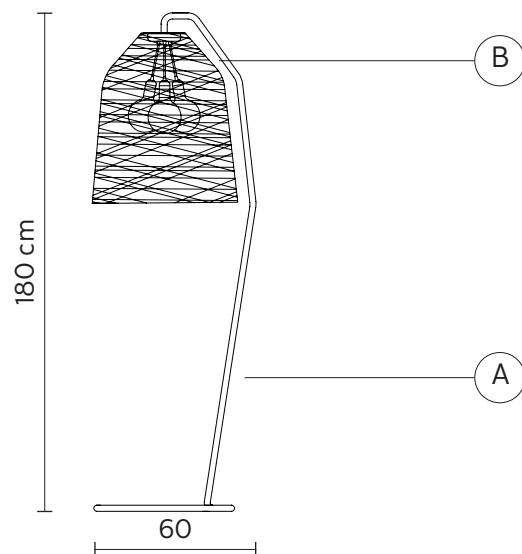

### CERTIFICATION

IEC	60598-1:2008
EN	60598-1:2008 + A11:2009



IP rate	IP20
bulb	not provided

### COLLECTION

available also as: suspension (indoor e outdoor)

