

connect

Supporto pensato per installare le Tv di nuova generazione a parete o in centro stanza con la massima flessibilità. Il sistema di integrazione cavi studiato da extendo consente di nascondere completamente i cavi lasciando libertà di rotazione di 360° della Tv. Il supporto rotante e il contenimento di apparati multimediali nella parte sottostante sono accessori.

This is a TV support column designed to host new generation TV installations either mounted on the wall or in the centre of the room with the utmost flexibility. The cable integration system designed by extendo makes it possible to completely conceal cables enabling the TV to freely rotate a full 360°. The turntable swivel base and the multimedia device cable containment system in the lower part of the support column are accessories.

Support conçu pour installer les téléviseurs de nouvelle génération au mur ou au centre de la pièce avec une flexibilité maximale. Le système d'intégration des câbles, conçu par extendo, permet de cacher complètement les câbles en laissant la liberté de rotation de 360° du téléviseur. Le support pivotant et le récipient pour appareils multimédias dans la partie en dessous sont des accessoires.

Fernsehhalterung für die Installation von TV-Geräten der neuesten Generation an der Wand oder in der Raummitte, für maximale Flexibilität bei der Positionierung. Dank der von extendo entwickelten, integrierten Kabelführung lassen sich die Gerätekabel völlig verstecken, wobei das Gerät um 360 Grad schwenkbar bleibt. Die Drehhalterung und die unterhalb anzubringenden Fächer für Multimedia-Geräte sind als Zubehör erhältlich.

Soporte pensado para instalar televisores de nueva generación en la pared o en una posición central en el ambiente, con la máxima flexibilidad. El sistema de integración de cables estudiado por extendo, permite ocultar los cables por completo, dejando libertad de rotación de 360° para el televisor. Cuenta con accesorios en la parte de abajo: un soporte giratorio y un espacio para posicionar dispositivos multimedia.



i cavi della TV e di eventuali unità multimediali sono completamente nascosti.
the TV and multimedia unit wires are completely hidden.
les fils de la TV et des unités multimédias sont complètement dissimulés.
Die Kabel des Fernsehers und der Multimedia sind vollkommen unsichtbar.
los cables de la TV y de los sistemas multimedia quedan completamente ocultos.

supporto monitor universale per TV da 19 a 65 pollici.
universal monitor support for TV from 19 to 65 inches.
support moniteur universel pour TV de 19 à 65 pouces.
Universal-Monitor-Halter für TV von 19 bis 65 Zoll.
soporte de monitor universal para TV de 19 a 65 pulgadas.

materiali / materials



HPL+legno
HPL+wood
HPL+bois
HPL+Holz
HPL+madera



legno massiccio
solid wood
bois massif
Massivholz
madera maciza

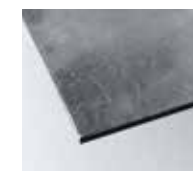

acciaio
steel
acier
Stahl
acero

Le materie prime che costituiscono il sistema connect derivano da un processo di riutilizzo e sono a loro volta riciclabili.

The primary materials used in the system connect are sourced from a reuse process, and are in turn recyclable.

Les matières premières qui composent le système connect dérivent d'un processus de réutilisation et sont à leur tour recyclables.

Die Rohstoffe für das System connect entstammen einem Wiederverwertungsprozess und sind ihrerseits wiederum recyclebar.

Las materias primas que constituyen el sistema connect proceden de un proceso de reutilización y son, a su vez, reciclables.

finiture / finishes

top / top / plateaux / Platte / plano

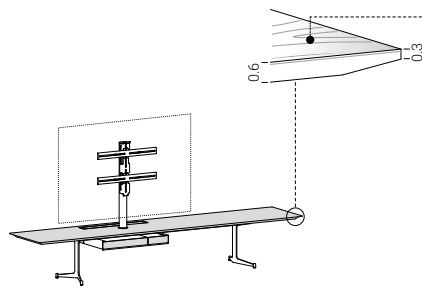

- HPL
- L03** bianco white
 - L08** grigio Londra London grey
 - L06** nero black
- FENIX NTM®**
- HPL + legno/wood bois/Holz madera
- Y36** rovere oak
 - Y34** noce walnut
 - Y37** rovere affumicato smoked oak
 - Y39** frassino nero black ash
- HPL + ottone/brass laiton/Messing latón
- C31** ottone brass
- eco-touch**
- N01** sabbia sand
 - N02** basalto basalt

telaio / structure / châssis / Gestell / bastidor

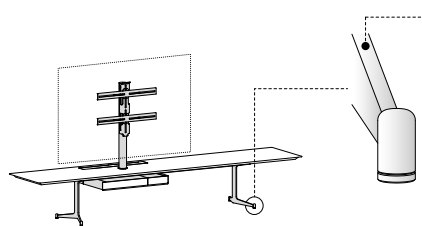

- acciaio verniciato powder coating steel acier peint lackierter Stahl acero pintado
- C12** bianco white
 - C21** seta silk
 - C23** corda ecru
 - C30** ghisa cast-iron
 - C14** antracite anthracite
 - C08** nero black
 - C18** verde green
 - C26** corten corten
 - C29** bronzo bronze

dimensioni / dimensions

panca porta TV / bench TV support / banc TV / Fernsehbank / banco de TV

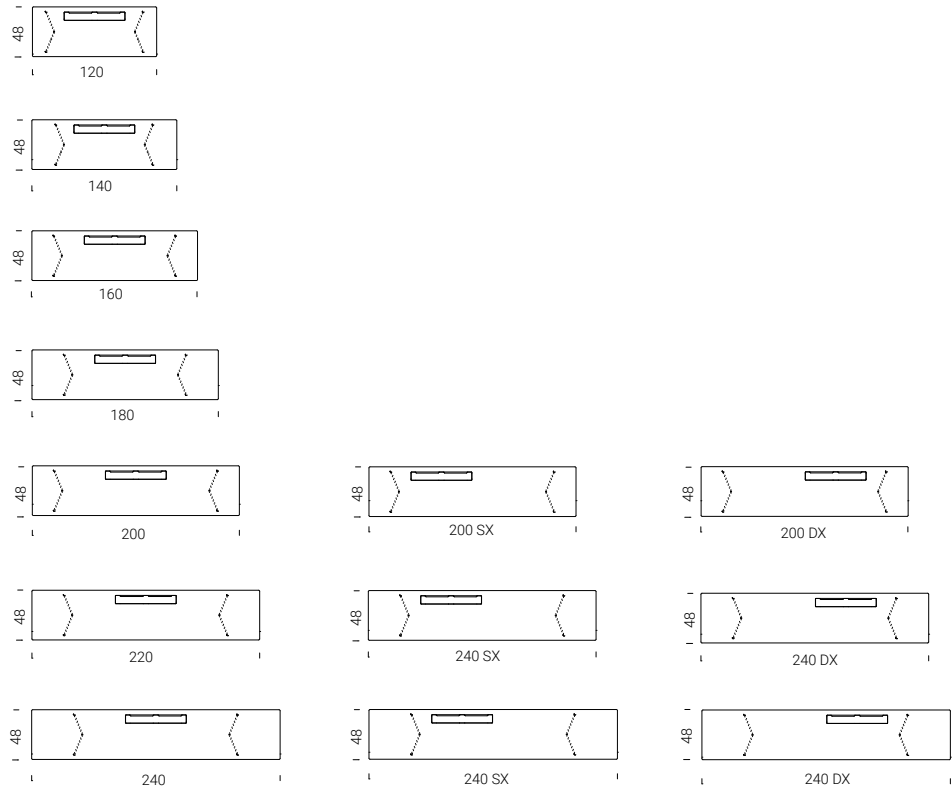

accessori / accessories / accessoires / Zubehör / accesorios

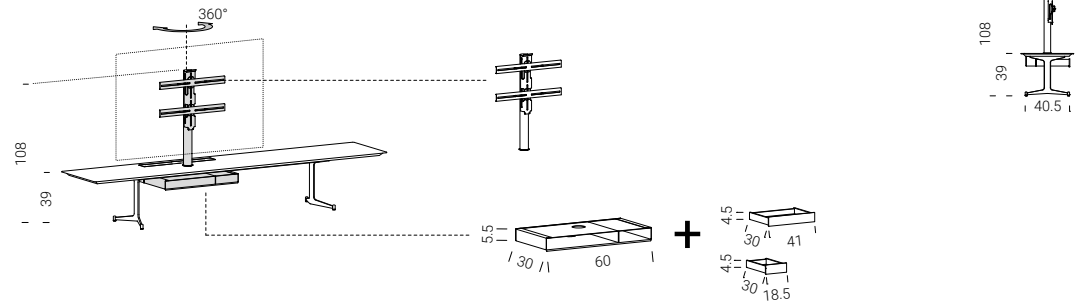

⚠ verificare a listino geometrie e finiture / check profiles and finishings in the price list / vérifier sur la liste de prix les géométries et les finitions / Siehe Preisliste für Ausführungen und Oberflächen / averiguar geometrías y acabados en la lista





connect CN01

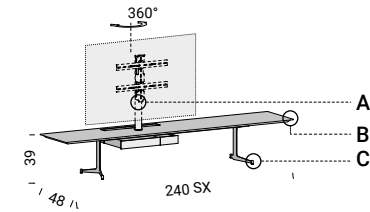

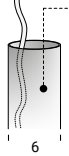
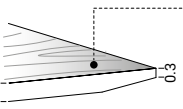
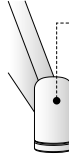
- A**
- 
- C08**
nero/black
- acciaio verniciato a polveri
powder coated steel
acier peint aux poudres
Pulverlackierter Stahl
Acero con baño de barniz en polvo
- B**
- 
- Y39**
frassino nero/black ash
- HPL impiallacciato
veneered HPL
HPL plaqué
HPL mit Furnier
HPL chapado
- C**
- 
- C08**
nero/black
- acciaio verniciato a polveri
powder coated steel
acier peint aux poudres
Pulverlackierter Stahl
Acero con baño de barniz en polvo

collection info
pg. 258









connect CN02

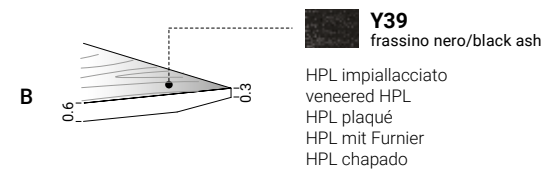
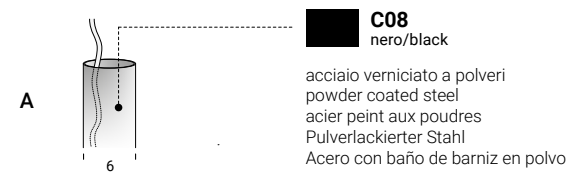
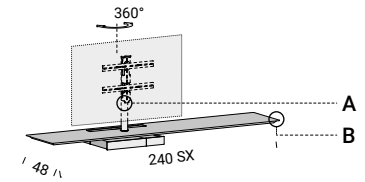

collection info
pg. 258