

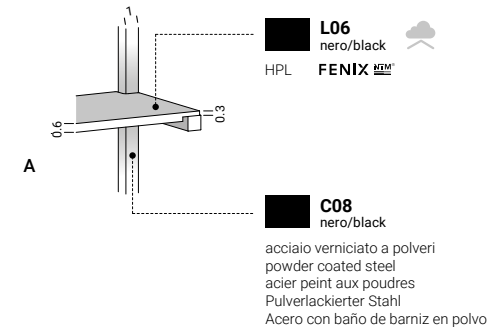

atelier
AT08

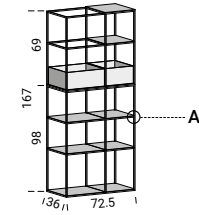

collection info
pg. 08