

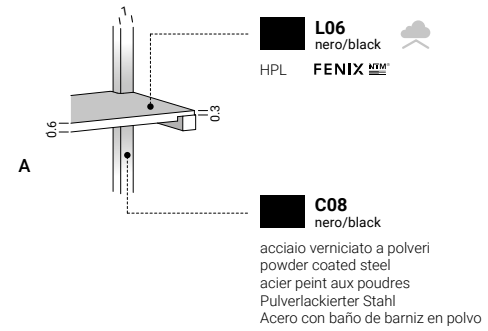

atelier AT07

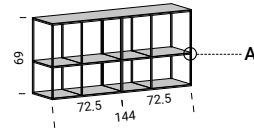

collection info
pg. 08