



déco

Una collezione di tavolini che si ispira ad uno stile che ha influenzato l'architettura ed il design negli anni 30. Le nuove tecnologie per la lavorazione dei metalli e le alte performance dei materiali impiegati, hanno consentito di reinterpretare uno stile dalle forme classiche in geometrie contemporanee.

This is a collection of coffee tables inspired by a style that influenced both the fields of architecture and design during the 1930s. The new metalworking technologies and the high-performing materials used, have made it possible to re-interpret a style with classical forms in contemporary profiles.

Une collection de tables basses qui s'inspire d'un style qui a influencé l'architecture et le design dans les années 30. Les nouvelles technologies pour l'usinage des métaux et les performances élevées des matériaux employés ont permis de réinterpréter un style aux formes classiques en géométries contemporaines.

Eine Kollektion von Tischen, die sich am Art Déco inspiriert, einer Stilrichtung, die die Architektur und das Design der 1930er Jahre beeinflusst hat. Innovative Technologien bei der Metallbearbeitung und leistungsfähige Materialien erlauben die Neuinterpretation eines von klassischen Formen geprägten Stils, die mit zeitgenössischen Konturen überzeugt.

Una colección de mesitas inspirada en el estilo que predominó en la arquitectura y el diseño de los años 30. Las nuevas tecnologías para el procesamiento de metales y las altas prestaciones de los materiales utilizados, permitieron reinterpretar un estilo caracterizado por formas clásicas, creando geometrías contemporáneas.



materiali / materials



HPL+legno
HPL+wood
HPL+bois
HPL+Holz
HPL+madera



HPL



acciaio
steel
acier
Stahl
acero

Le materie prime che costituiscono il sistema déco derivano da un processo di riutilizzo e sono a loro volta riciclabili.

The primary materials used in the system déco are sourced from a reuse process, and are in turn recyclable.

Les matières premières qui composent le système déco dérivent d'un processus de réutilisation et sont à leur tour recyclables.

Die Rohstoffe für das System déco entstammen einem Wiederverwertungsprozess und sind Ihrerseits wiederum recyclebar.

Las materias primas que constituyen el sistema déco proceden de un proceso de reutilización y son, a su vez, reciclables.

finiture / finishes

top tavolo / table top / plateaux de table / Tischplatte / plano de mesa

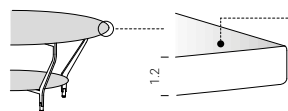

- marmo
marble
marbre
Marmor
mármol
-  **Z01** bianco Carrara
white Carrara
 -  **Z02** nero Marquifia
black Marquifia

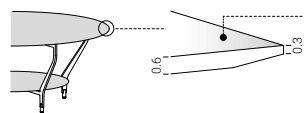

- HPL
-  **L03** bianco
white
 -  **L08** grigio Londra
London grey
 -  **L06** nero
black
- FENIX NTM®**
-  **Y36** rovere
oak
 -  **Y34** noce
walnut
 -  **Y37** rovere affumicato
smoked oak
 -  **Y39** frassino nero
black ash
- HPL + legno/wood
bois/Holz
madera
- HPL + ottone/brass
laiton/Messing
latón
-  **C31** ottone
brass
- eco-touch**
-  **N01** sabbia
sand
 -  **N02** basalto
basalt



telaio / structure / châssis / Gestell / bastidor

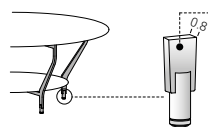

- acciaio verniciato
painted steel
acier peint
lackierter Stahl
acero pintado
-  **C12** bianco
white
 -  **C21** seta
silk
 -  **C23** corda
ecru
 -  **C30** ghisa
cast-iron
 -  **C14** antracite
anthracite
 -  **C08** nero
black
 -  **C18** verde
green
 -  **C26** corten
corten
 -  **C29** bronzo
bronze



 uso in esterno riparato
protected outdoor use

dimensioni / dimensions

tavoli bassi / coffee tables / tables basses / Couchtische / mesas bajas

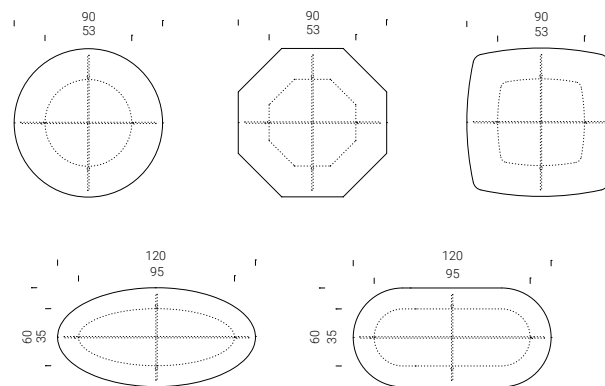

tavoli bassi / coffee tables / tables basses / Couchtische / mesas bajas

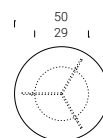

 verificare a listino geometrie e finiture / check profiles and finishings in the price list / vérifier sur la liste de prix les géométries et les finitions / Siehe Preisliste für Ausführungen und Oberflächen / averiguar geometrias y acabados en la lista