



# déco

**Una collezione di tavolini che si ispira ad uno stile che ha influenzato l'architettura ed il design negli anni 30. Le nuove tecnologie per la lavorazione dei metalli e le alte performance dei materiali impiegati, hanno consentito di reinterpretare uno stile dalle forme classiche in geometrie contemporanee.**

This is a collection of coffee tables inspired by a style that influenced both the fields of architecture and design during the 1930s. The new metalworking technologies and the high-performing materials used, have made it possible to re-interpret a style with classical forms in contemporary profiles.

Une collection de tables basses qui s'inspire d'un style qui a influencé l'architecture et le design dans les années 30. Les nouvelles technologies pour l'usinage des métaux et les performances élevées des matériaux employés ont permis de réinterpréter un style aux formes classiques en géométries contemporaines.

Eine Kollektion von Tischen, die sich am Art Déco inspiriert, einer Stilrichtung, die die Architektur und das Design der 1930er Jahre beeinflusst hat. Innovative Technologien bei der Metallbearbeitung und leistungsfähige Materialien erlauben die Neuinterpretation eines von klassischen Formen geprägten Stils, die mit zeitgenössischen Konturen überzeugt.

Una colección de mesitas inspirada en el estilo que predominó en la arquitectura y el diseño de los años 30. Las nuevas tecnologías para el procesamiento de metales y las altas prestaciones de los materiales utilizados, permitieron reinterpretar un estilo caracterizado por formas clásicas, creando geometrías contemporáneas.



## materiali / materials



HPL+legno  
HPL+wood  
HPL+bois  
HPL+Holz  
HPL+madera

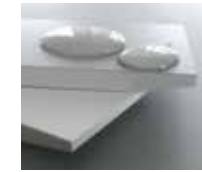

HPL



acciaio  
steel  
acier  
Stahl  
acero

Le materie prime che costituiscono il sistema déco derivano da un processo di riutilizzo e sono a loro volta riciclabili.

The primary materials used in the system déco are sourced from a reuse process, and are in turn recyclable.

Les matières premières qui composent le système déco dérivent d'un processus de réutilisation et sont à leur tour recyclables.

Die Rohstoffe für das System déco entstammen einem Wiederverwertungsprozess und sind Ihrerseits wiederum recyclebar.

Las materias primas que constituyen el sistema déco proceden de un proceso de reutilización y son, a su vez, reciclables.

# finiture / finishes

## top tavolo / table top / plateau de table / Tischplatte / plano de mesa

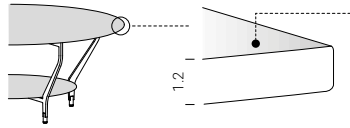

marmo  
marble  
marbre  
Marmor  
mármol

**Z01** bianco Carrara  
white Carrara

**Z02** nero Marquiña  
black Marquiña

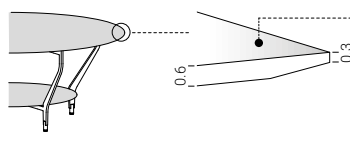

HPL

**FENIX NTM®** **L03** bianco  
white

**FENIX NTM®** **L08** grigio Londra  
London grey

**FENIX NTM®** **L06** nero  
black

HPL + legno/wood  
bois/Holz  
madera

**Y36** rovere  
oak

**Y34** noce  
walnut

**Y37** rovere affumicato  
smoked oak

**Y39** frassino nero  
black ash

HPL + ottone/brass  
laiton/Messing  
latón

**C31** ottone  
brass

**eco-touch** **N01** sabbia  
sand

**eco-touch** **N02** basalto  
basalt

## telaio / structure / châssis / Gestell / bastidor

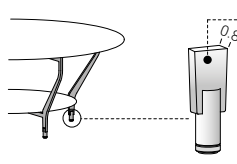

acciaio verniciato  
painted steel  
acier peint  
lackierter Stahl  
acero pintado

**C12** bianco  
white

**C21** seta  
silk

**C23** corda  
ecru

**C30** ghisa  
cast-iron

**C14** antracite  
anthracite

**C08** nero  
black

**C18** verde  
green

**C26** corten  
corten

**C29** bronzo  
bronze

 uso in esterno riparato  
protected outdoor use

# dimensioni / dimensions

## tavoli bassi / coffee tables / tables basses / Couchtische / mesas bajas

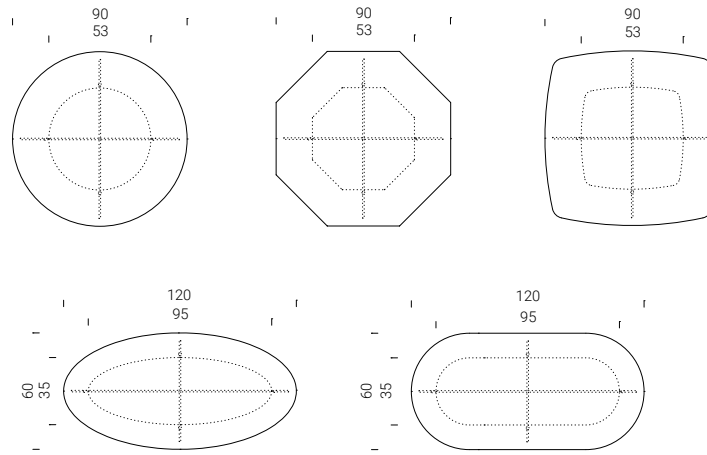

## tavoli bassi / coffee tables / tables basses / Couchtische / mesas bajas

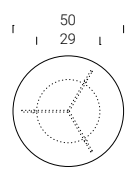

 verificare a listino geometrie e finiture / check profiles and finishings in the price list / vérifier sur la liste de prix les géométries et les finitions / Siehe Preisliste für Ausführungen und Oberflächen / averiguar geometrías y acabados en la lista



**déco**  
DE03

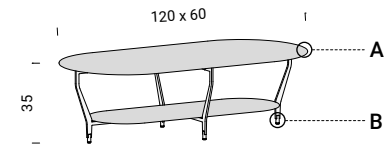

**A**

**Y37**  
rovere affumicato/smoked oak

HPL impiallacciato  
wood-veneered HPL  
HPL plaqué bois  
HPL mit Holzfurnier  
HPL contrachapado madera

**B**

**C29**  
bronzo/brnze

acciaio verniciato a polveri  
powder coated steel  
acier peint aux poudres  
Pulverlackierter Stahl  
Acero con baño de barniz en polvo

collection info  
pg. 220



**déco**  
DE06

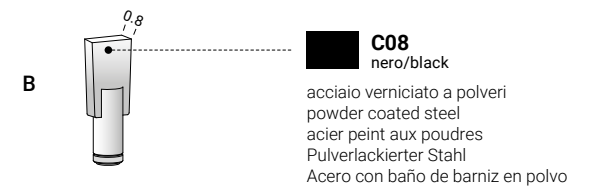
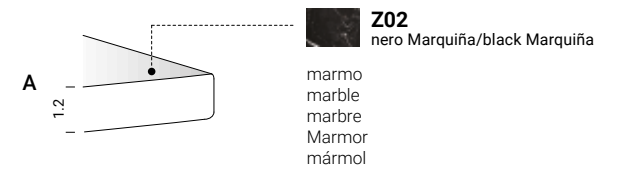
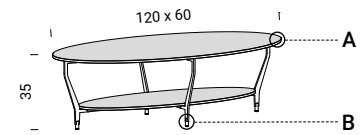

collection info  
pg. 220



## déco

DE01

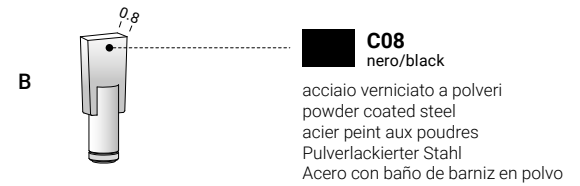
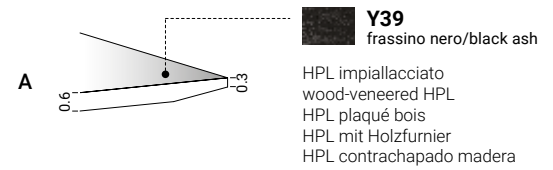
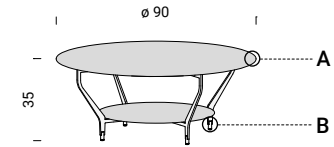

collection info  
pg. 220



**déco**  
DE05

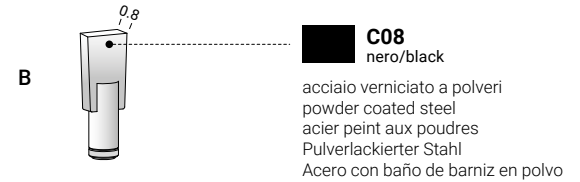
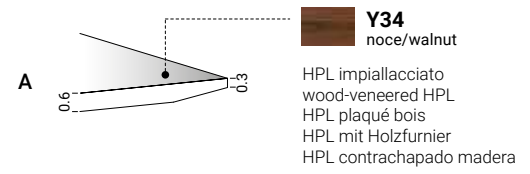
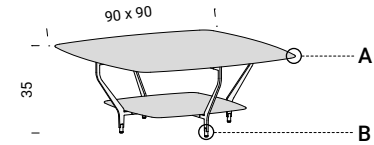

collection info  
pg. 220



**déco**  
DE02

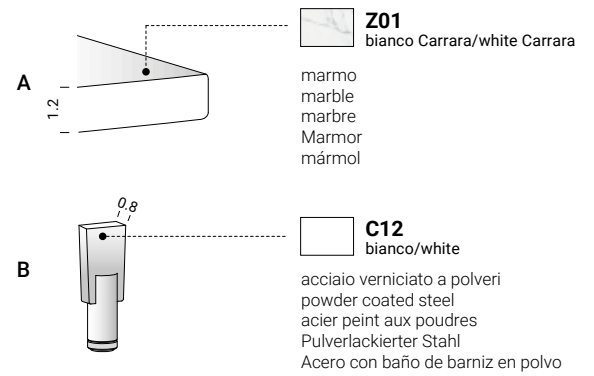
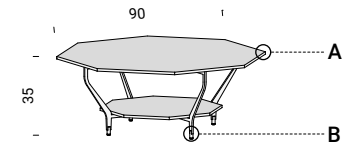

collection info  
pg. 220



## déco

DE04

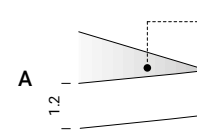
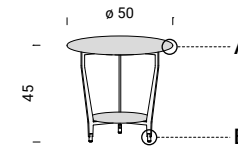

**Z02**  
nero Marquiña/black Marquiña

marmo  
marble  
marbre  
Marmor  
mármol

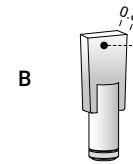

**C14**  
antracite/anthracite

acciaio verniciato a polveri  
powder coated steel  
acier peint aux poudres  
Pulverlackierter Stahl  
Acero con baño de barniz en polvo

collection info  
pg. 220