



viking

La lama in acciaio che ricorda il profilo di chiglia delle navi vichinghe è la spina dorsale di tutte le sedute che fanno parte della collezione. Su di essa si innestano il fondello lo schienale e gli appoggi a terra. Il telaio è in acciaio, mentre i componenti di seduta e schienale sono disponibili in multistrato o cuoio.

The steel blade recalling the contour of the keel of Viking ships is the backbone of all the chairs belonging to this collection. The chair seat, the backrest and the chair legs are inserted onto this. The chair frame is made of steel, while the seat and backrest are available in either plywood or leather.

La lame en acier qui rappelle le profil de la quille des navires vikings est l'épine dorsale de toutes les assises qui font partie de la collection. C'est sur elle que s'enclenchent le fond, le dossier et les appuis au sol. Le châssis est en acier alors que les composants de l'assise et du dossier sont disponibles en multicouche ou en cuir.

Ein Stahlprofil, das an den Rumpf der Wikingerschiffe erinnert, stellt das Rückgrat aller Stühle dieser Kollektion dar, an dem die Sitzfläche, die Rückenlehne und die Bodenstützen befestigt sind. Der Rahmen ist aus Stahl gefertigt, während die Sitzflächen und die Lehnen in Sperrholz oder Leder erhältlich sind.

La cuchilla de acero que recuerda el perfil de la quilla de los barcos vikingos, es la espina dorsal de todos los asientos que forman parte de la colección. Sobre ella, se ensamblan el fondo, el respaldo y los apoyos en el suelo. El bastidor es de acero, mientras que los componentes del asiento y el respaldo, están disponibles en madera estratificada o cuero.



materiali / materials

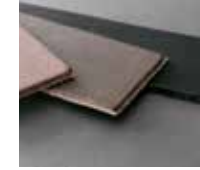

cuoio
cow-hide
cuir
Kernleder
cuero



multistrato
plywood
contre-plaqué
Sperrholz
contrachapado



acciaio
steel
acier
Stahl
acero

Le materie prime che costituiscono il sistema viking derivano da un processo di riutilizzo e sono a loro volta riciclabili.

The primary materials used in the system viking are sourced from a reuse process, and are in turn recyclable.

Les matières premières qui composent le système viking dérivent d'un processus de réutilisation et sont à leur tour recyclables.

Die Rohstoffe für das System viking entstammen einem Wiederverwertungsprozess und sind Ihrerseits wiederum recyclebar.

Las materias primas que constituyen el sistema viking proceden de un proceso de reutilización y son, a su vez, reciclables.

finiture / finishes

fondello e schienale / seat and back / assise et dossier / Sitzfläche und Rückenlehne / asiento y respaldo

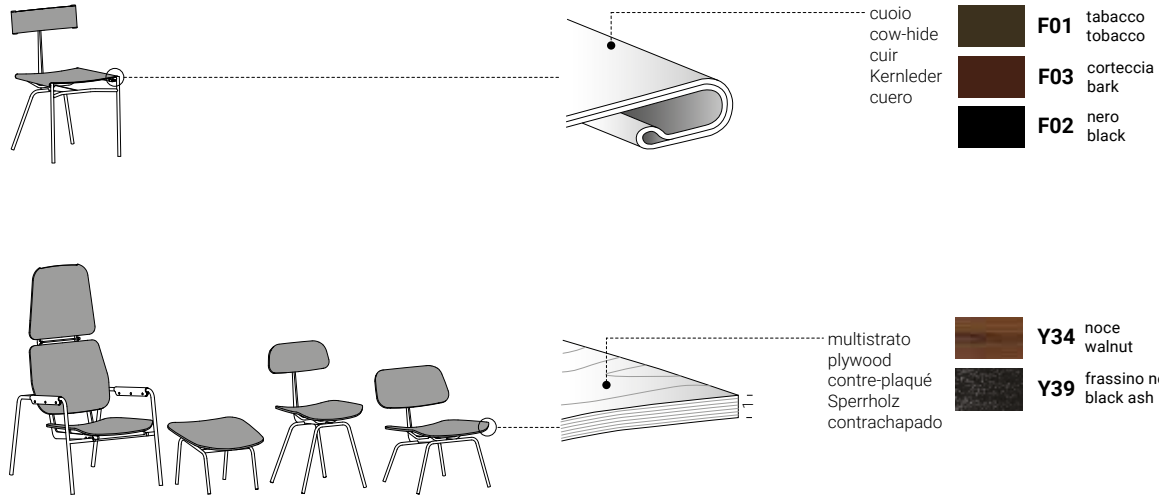

telaio / structure / châssis / Gestell / bastidor

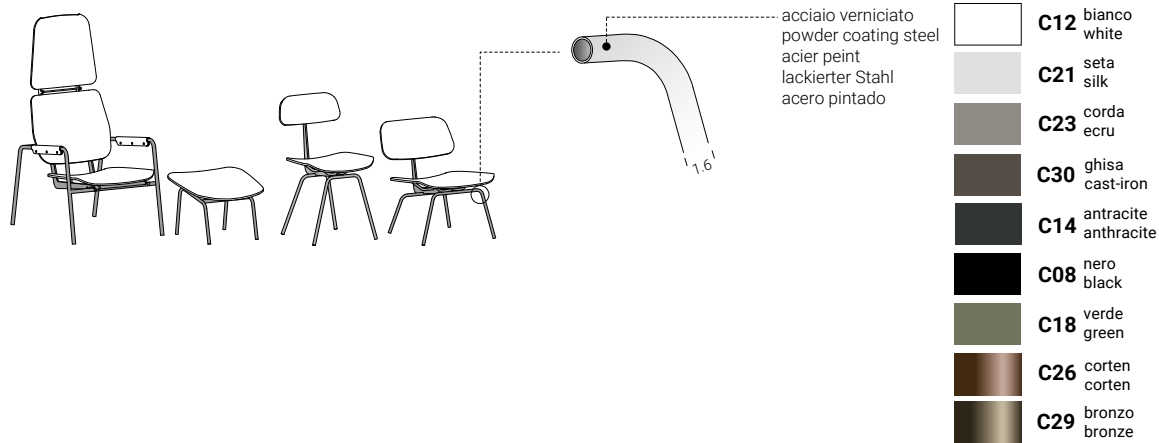

cuscino / cushion / coussin / Kissen / cojín

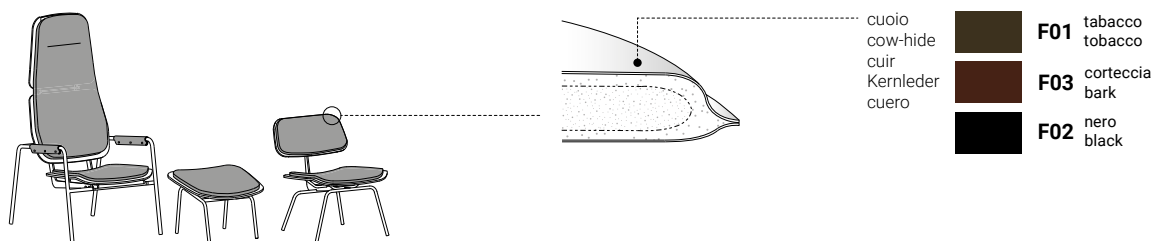

dimensioni / dimensions

sedie / chairs / chaises / Stühle / sillas

K

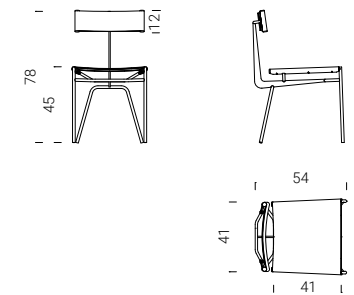

W

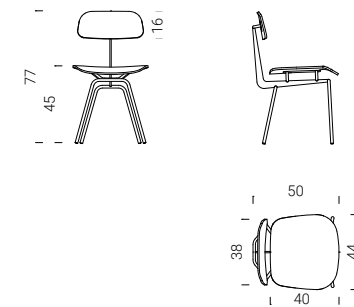

L

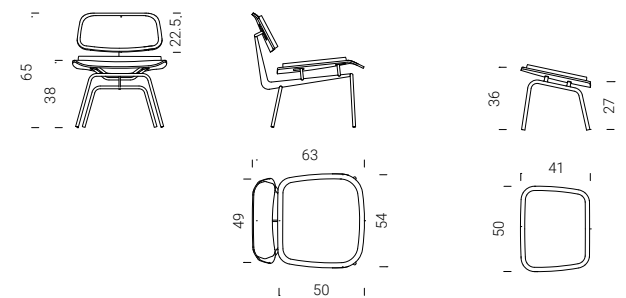

GL

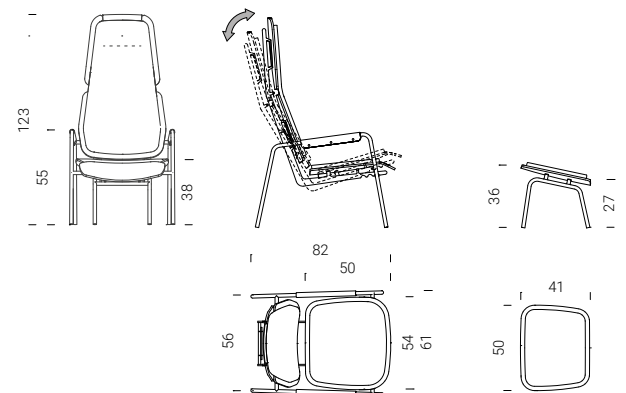





viking K

VK01

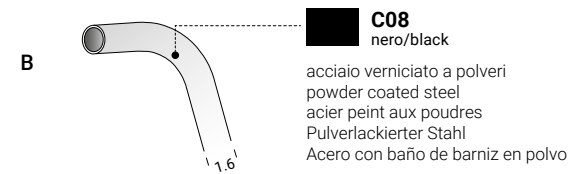
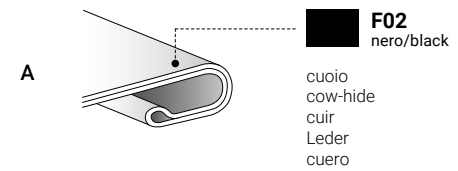
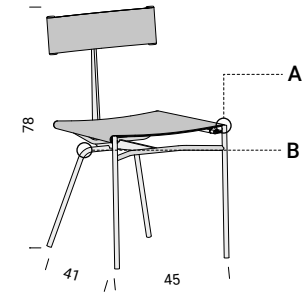

collection info
pg. 230









viking W

VK02

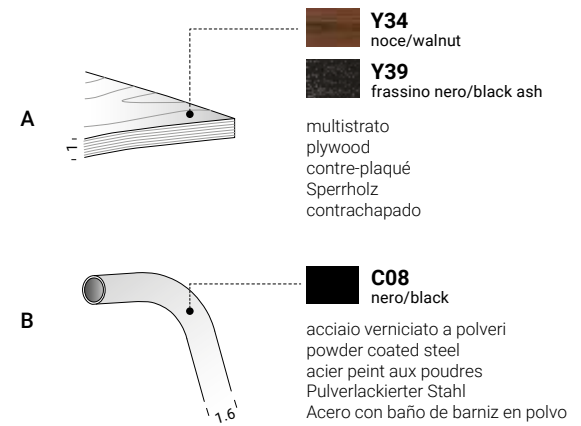
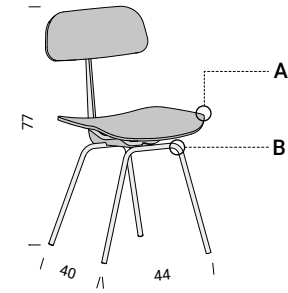

collection info
pg. 230





viking L

VK03

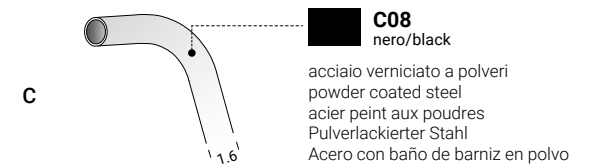
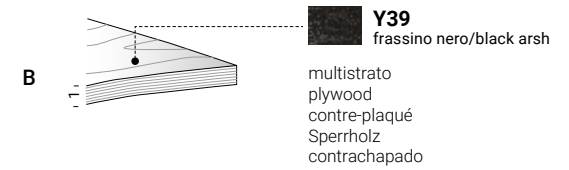
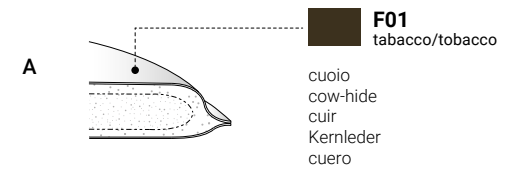
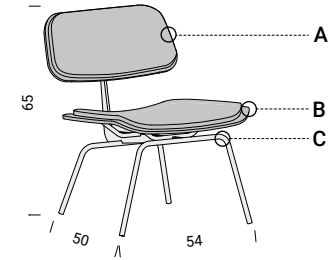

collection info
pg. 230





viking GL

VK04

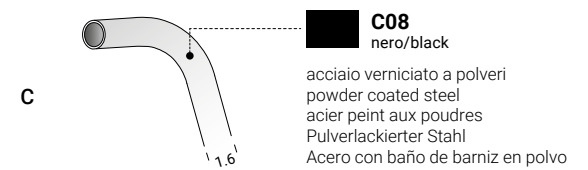
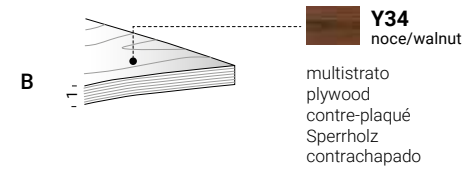
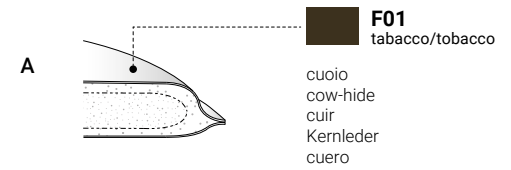
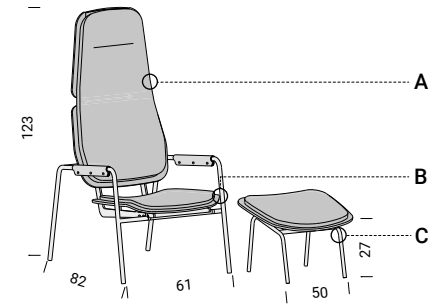

collection info
pg. 230



