

## materiali / materials



alluminio  
aluminium  
Aluminium  
aluminio



vetro  
glass  
verre  
Glas  
cristal



MDF  
DM

Le materie prime che costituiscono il sistema monolith derivano da un processo di riutilizzo e sono a loro volta riciclabili.

The primary materials used in the system monolith are sourced from a reuse process, and are in turn recyclable.

Les matières premières qui composent le système monolith dérivent d'un processus de réutilisation et sont à leur tour recyclables.

Die Rohstoffe für das System monolith entstammen einem Wiederverwertungsprozess und sind Ihrerseits wiederum recyclebar.

Las materias primas que constituyen el sistema monolith proceden de un proceso de reutilización y son, a su vez, reciclables.



# finiture / finishes

## scocche / shells / cadres / Gehäuse / estructuras

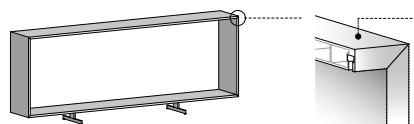

alluminio verniciato  
painted aluminium  
aluminium peint  
lackierter Aluminium  
aluminio pintado

- C12** bianco white
- C21** seta silk
- C23** corda ecru
- C30** ghisa cast-iron
- C14** antracite anthracite
- C08** nero black
- C29** bronzo bronze

## fianchi interni / inner sides / côtés internes / Innenseiten / paredes interiores

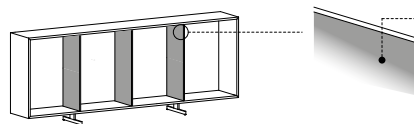

MDF laccato  
lacquered MDF  
MDF laqué  
lackiertem MDF  
DM lacado

- Q05** bianco white
- Q16** seta silk
- Q17** corda ecru
- Q20** ghisa cast-iron
- Q14** antracite anthracite
- Q04** nero black
- Q21** bronzo bronze

## ripiani interni / inner shelving / étagères internes / Innenböden / estantes interiores

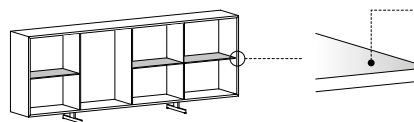

vetro laccato  
lacquered glass  
verre laqué  
lackiertem Glas  
cristal lacado

- V01** bianco white
- V15** seta silk
- V16** corda ecru
- V23** ghisa cast-iron
- V12** antracite anthracite
- V02** nero black
- V24** bronzo bronze
- V07** float
- V06** fumè smoked glass

## schiene / backs / dos / Rückwände / traseras

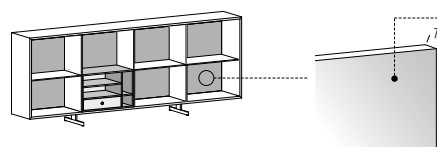

MDF laccato  
lacquered MDF  
MDF laqué  
lackiertem MDF  
DM lacado

- Q05** bianco white
- Q16** seta silk
- Q17** corda ecru
- Q20** ghisa cast-iron
- Q14** antracite anthracite
- Q04** nero black
- Q21** bronzo bronze
- Y36** rovere oak
- Y35** noce walnut

essenze  
woods  
bois  
Holzes  
maderas

## frontali / doors fronts / faces des portes / Fronten der Türen / frontales de las puertas

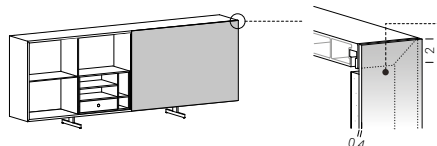

vetro laccato  
lacquered glass  
verre laqué  
lackiertem Glas  
cristal lacado

- V01** bianco white
- V15** seta silk
- V16** corda ecru
- V23** ghisa cast-iron
- V12** antracite anthracite
- V02** nero black
- V24** bronzo bronze
- V06** fumè smoked glass

## top

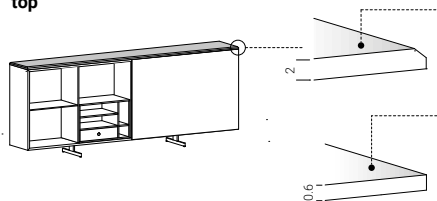

marmo  
marble  
marbre  
Marmor  
mármol

- Z01** bianco Carrara white Carrara
- Z02** nero Marquiffa black Marquiffa

HPL

**FENIX** NIM

**FENIX** NIM

- L03** bianco white
- L08** grigio Londra London grey
- L06** nero black

essenze  
woods  
bois  
Holzes  
maderas

- Y36** rovere oak
- Y34** noce walnut
- Y37** rovere affumicato smoked oak
- Y39** frassino nero black ash

# configurazioni / configurations

## H1

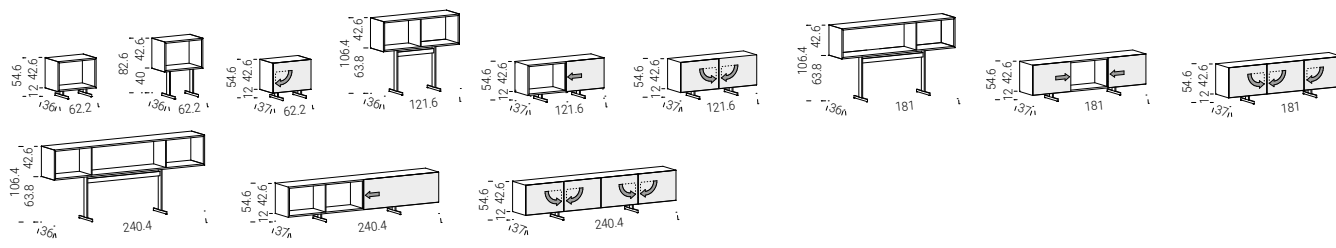

## H2

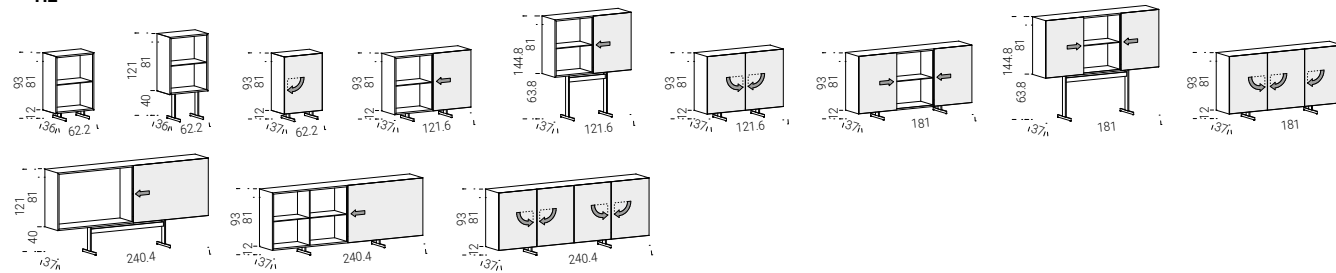

## H3

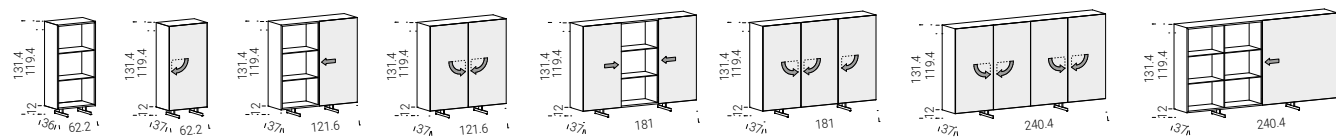

## H4

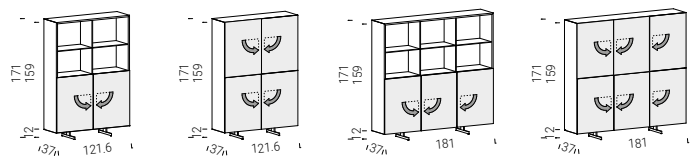

## H5

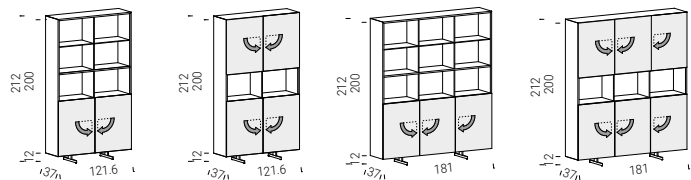

## accessori / accessories / accessoires Zubehör / accesorios

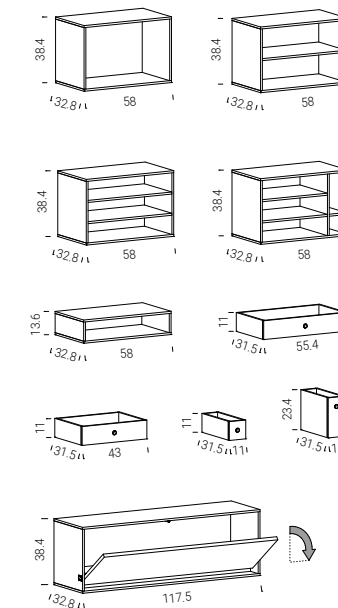

## basi / bases / bases / Basis / bases

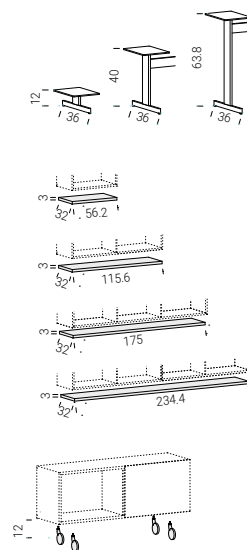

disponibili a listino ulteriori composizioni / further compositions available per pricelist / autres compositions disponibles sur la liste de prix / nach Preisliste stehen weitere Zusammenstellungen zur Verfügung / otras composiciones disponibles en la lista de precios