

# monolith

**La scocca in alluminio estruso che costituisce l'ossatura portante di monolith, consente grande rigidità strutturale e una libera configurazione delle partizioni interne. Tale sistema costruttivo forma un insieme molto semplice da assemblare e riconfigurare, evitando di raddoppiare gli spessori dei fianchi al suo interno.**

The frame in extruded aluminium forming the support structure of Monolith gives an extremely firm structure with free configuration of the inner partitions. This composition system forms a very simple set to assemble and re-configure, without doubling the thicknesses of its inner sides.

Le châssis en aluminium extrudé qui constitue l'ossature portante de monolith, permet une grande rigidité structurelle et une libre configuration des divisions internes. Ce système de construction forme un ensemble très simple à assembler et reconfigurer, en évitant de doubler les épaisseurs des côtés à l'intérieur.

Der Aufbau aus extrudiertem Aluminium, der das tragenden Gerüst des monolith darstellt, bietet eine bedeutende, strukturelle Steifheit und eine freie Konfigurierung der Innenaufteilung. Dieses Konstruktionssystem bildet eine Einheit, die einfach zusammenzubauen und neu zu gestalten ist, wobei die Verdoppelung der Stärke der Seiten im Innenbereich vermieden wird.

El bastidor de aluminio extruido que constituye el armazón de soporte de Monolith permite una gran resistencia estructural y una libre configuración de las particiones interiores. Este sistema de construcción forma un conjunto muy fácil de montar y reconfigurar, evitando duplicar el espesor de los laterales en su interior.



## materiali / materials



alluminio  
aluminium  
Aluminium  
aluminio



vetro  
glass  
verre  
Glas  
cristal



MDF  
DM



Le materie prime che costituiscono il sistema monolith derivano da un processo di riutilizzo e sono a loro volta riciclabili.

The primary materials used in the system monolith are sourced from a reuse process, and are in turn recyclable.

Les matières premières qui composent le système monolith dérivent d'un processus de réutilisation et sont à leur tour recyclables.

Die Rohstoffe für das System monolith entstammen einem Wiederverwertungsprozess und sind Ihrerseits wiederum recyclebar.

Las materias primas que constituyen el sistema monolith proceden de un proceso de reutilización y son, a su vez, reciclables.



# finiture / finishes

## scocche / shells / cadres / Gehäuse / estructuras

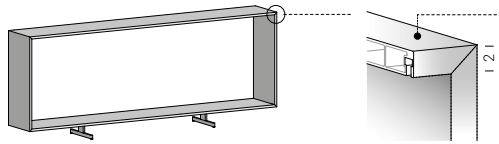

alluminio verniciato  
painted aluminium  
aluminium peint  
lackierter Aluminium  
aluminio pintado

	<b>C12</b>	bianco white
	<b>C21</b>	seta silk
	<b>C23</b>	corda ecru
	<b>C30</b>	ghisa cast-iron
	<b>C14</b>	antracite anthracite
	<b>C08</b>	nero black
	<b>C29</b>	bronzo bronze

## fianchi interni / inner sides / côtés internes / Innenseiten / paredes interiores

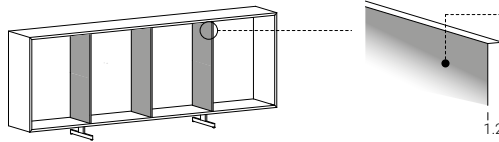

MDF laccato  
lacquered MDF  
MDF laqué  
lackiertem MDF  
DM lacado

	<b>Q05</b>	bianco white
	<b>Q16</b>	seta silk
	<b>Q17</b>	corda ecru
	<b>Q20</b>	ghisa cast-iron
	<b>Q14</b>	antracite anthracite
	<b>Q04</b>	nero black
	<b>Q21</b>	bronzo bronze

## ripiani interni / inner shelving / étagères internes / Innenböden / estantes interiores

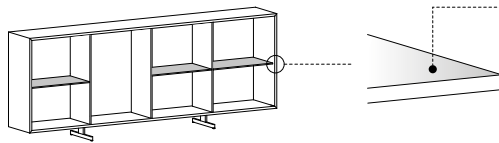

vetro laccato  
lacquered glass  
verre laqué  
lackiertem Glas  
cristal lacado

	<b>V01</b>	bianco white
	<b>V15</b>	seta silk
	<b>V16</b>	corda ecru
	<b>V23</b>	ghisa cast-iron
	<b>V12</b>	antracite anthracite
	<b>V02</b>	nero black
	<b>V24</b>	bronzo bronze
	<b>V07</b>	float
	<b>V06</b>	fumè smoked glass

## schiene / backs / dos / Rückwände / traseras

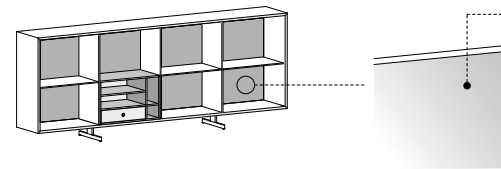

MDF laccato  
lacquered MDF  
MDF laqué  
lackiertem MDF  
DM lacado

	<b>Q05</b>	bianco white
	<b>Q16</b>	seta silk
	<b>Q17</b>	corda ecru
	<b>Q20</b>	ghisa cast-iron
	<b>Q14</b>	antracite anthracite
	<b>Q04</b>	nero black
	<b>Q21</b>	bronzo bronze

essenze woods		<b>Y36</b>	rovere oak
bois		<b>Y35</b>	noce walnut
Holzes			
maderas			

## frontali / doors fronts / faces des portes / Fronten der Türen / frontales de las puertas

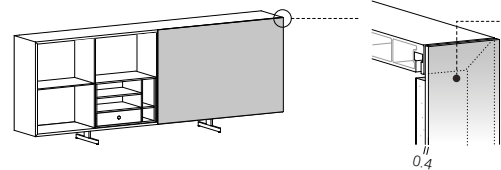

vetro laccato  
lacquered glass  
verre laqué  
lackiertem Glas  
cristal lacado

	<b>V01</b>	bianco white
	<b>V15</b>	seta silk
	<b>V16</b>	corda ecru
	<b>V23</b>	ghisa cast-iron
	<b>V12</b>	antracite anthracite
	<b>V02</b>	nero black
	<b>V24</b>	bronzo bronze
	<b>V06</b>	fumè smoked glass

## top

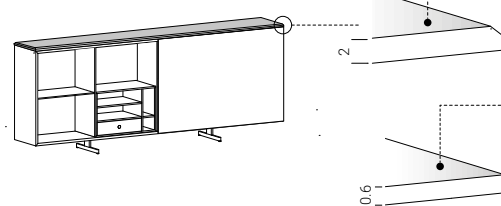

marmo marble		<b>Z01</b>	bianco Carrara white Carrara
marbre		<b>Z02</b>	nero Marquiffa black Marquiffa
Marmor			
mármol			

HPL		<b>L03</b>	bianco white
<b>FENIX<sup>NTM</sup></b>		<b>L08</b>	grigio Londra London grey
<b>FENIX<sup>NTM</sup></b>		<b>L06</b>	nero black

essenze woods		<b>Y36</b>	rovere oak
bois		<b>Y34</b>	noce walnut
Holzes		<b>Y37</b>	rovere affumicato smoked oak
maderas		<b>Y39</b>	frassino nero black ash

# configurazioni / configurations

## H1

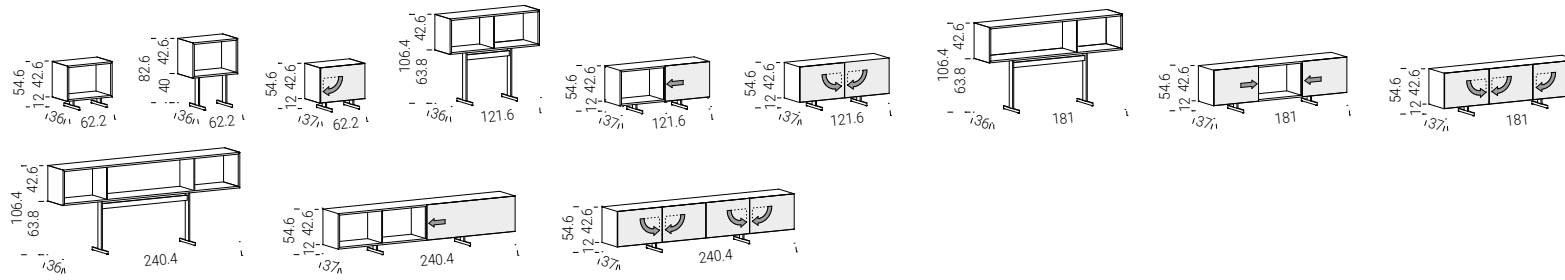

## H2

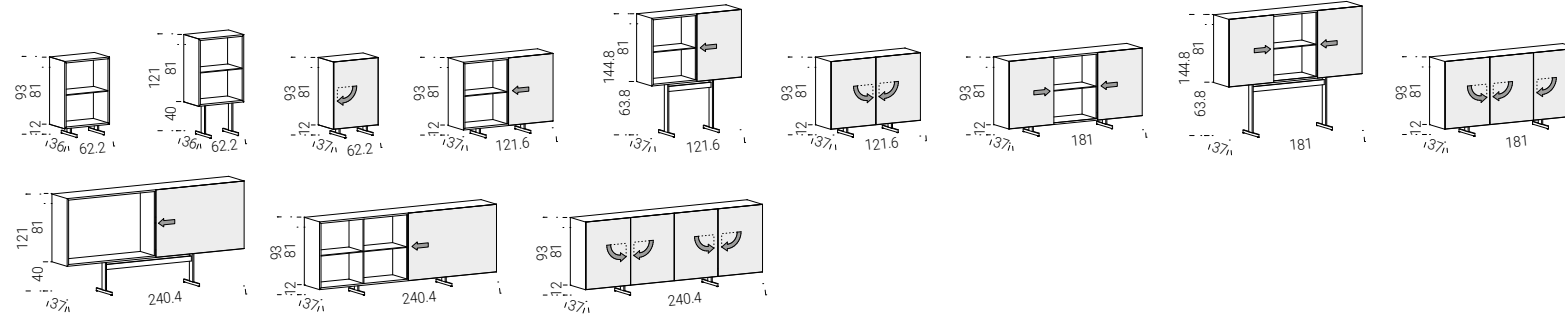

## H3

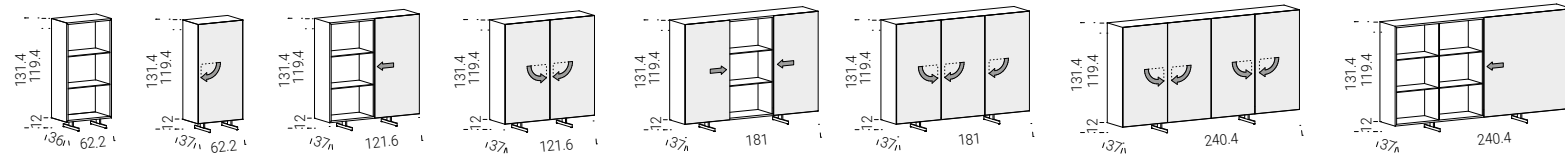

## H4

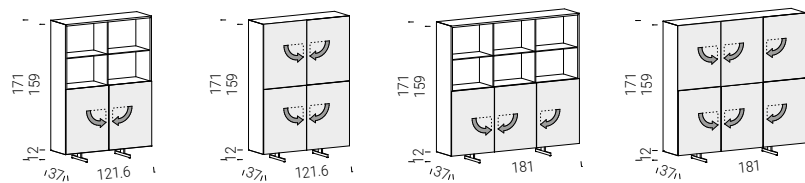

## H5

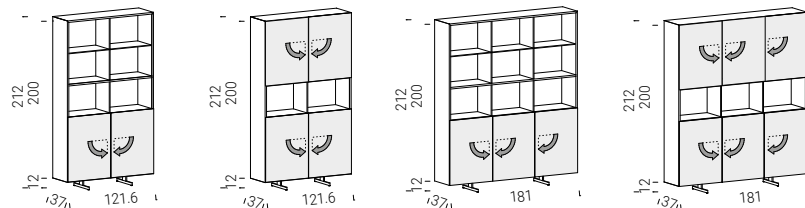

## accessori / accessories / accessoires Zubehör / accesorios

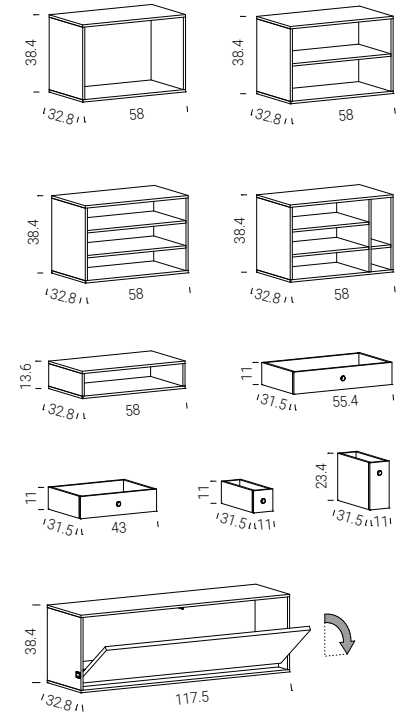

## basi / bases / bases / Basis / bases

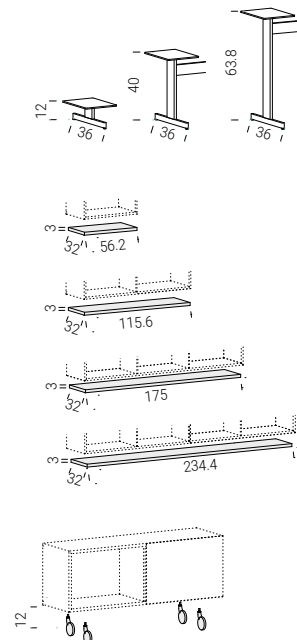

disponibili a listino ulteriori composizioni / further compositions available per pricelist / autres compositions disponibles sur la liste de prix / nach Preisliste stehen weitere Zusammenstellungen zur Verfügung / otras composiciones disponibles en la lista de precios





## monolith MN03

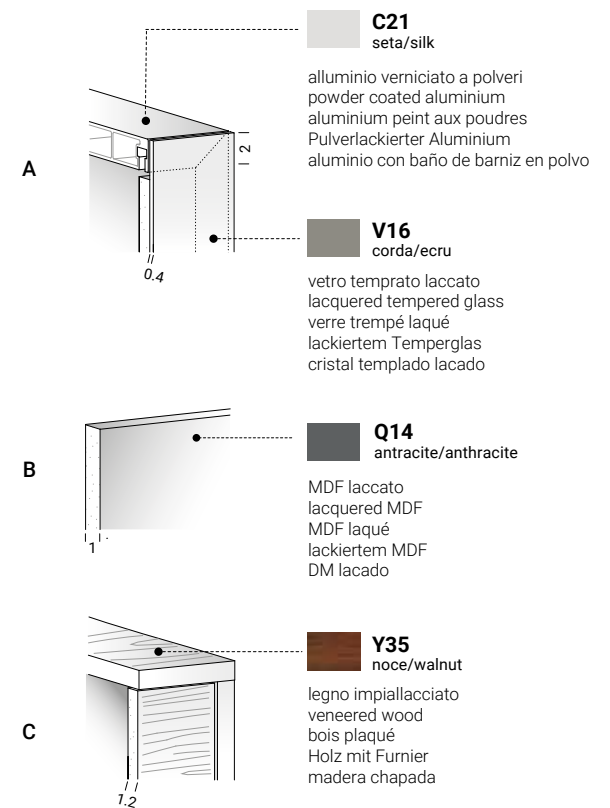
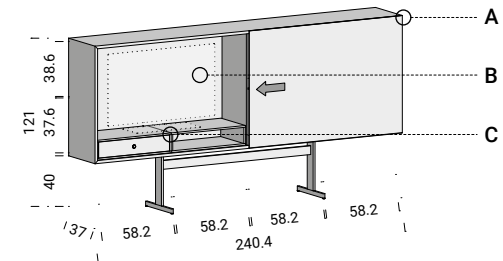

collection info  
pg. 26





# monolith

MN09

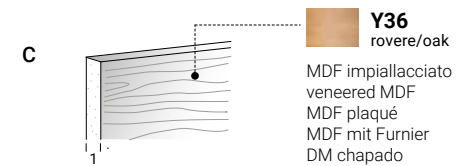
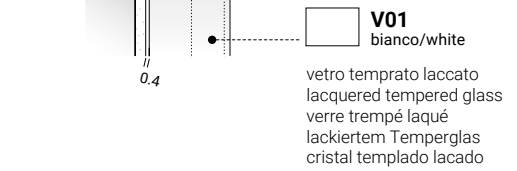
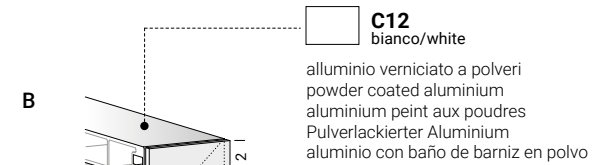
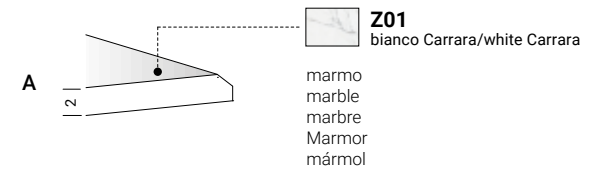
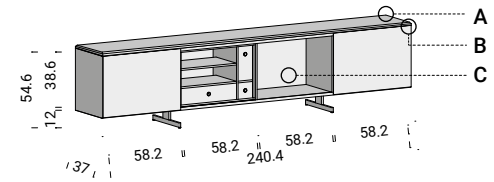

collection info  
pg. 26











## monolith MN08

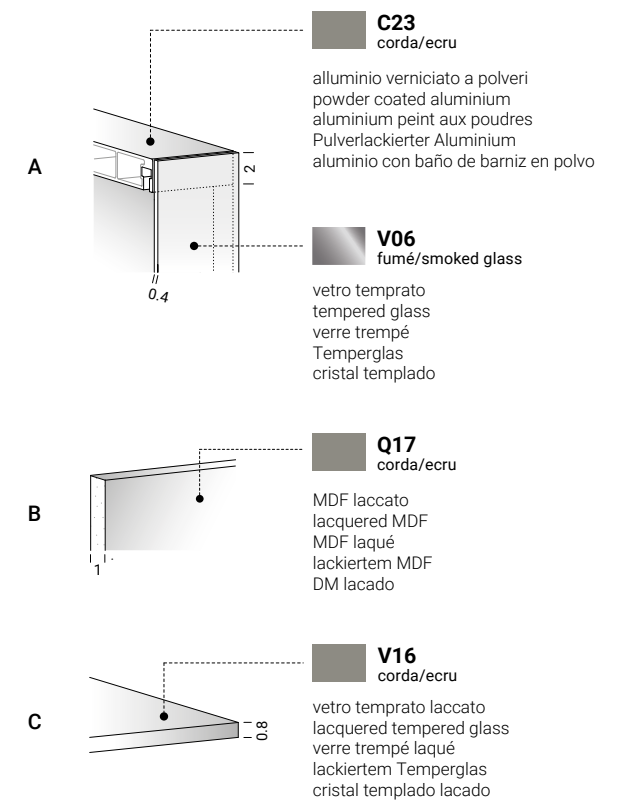
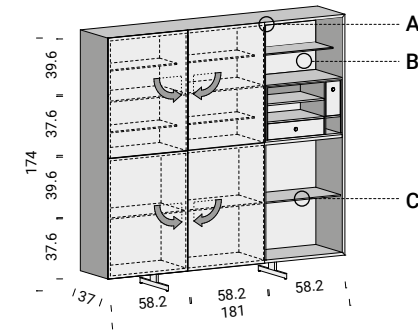

# monolith

MN02C

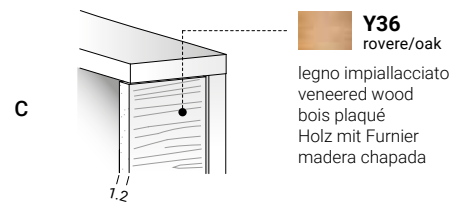
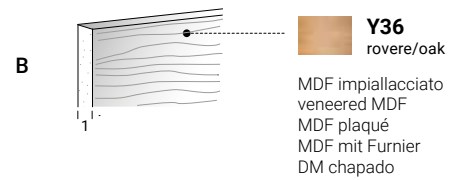
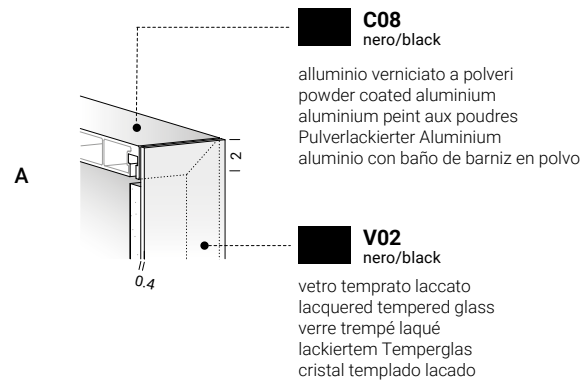
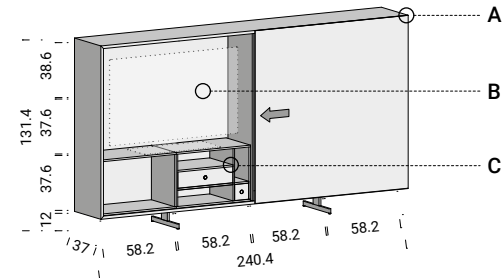

collection info  
pg. 26

# monolith

MN02B

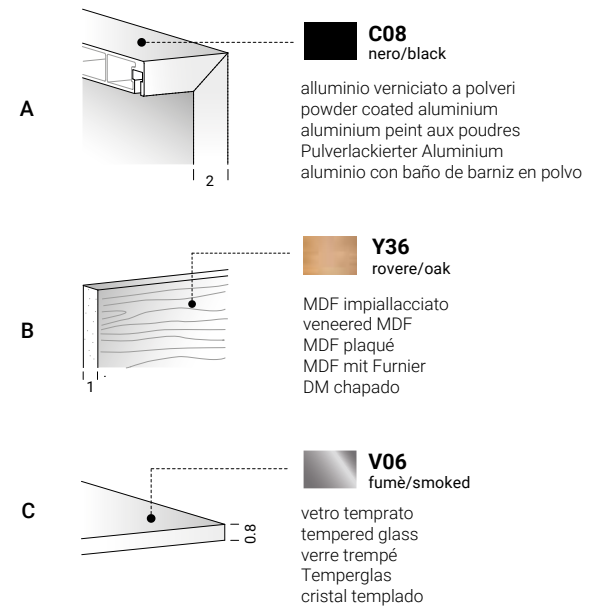
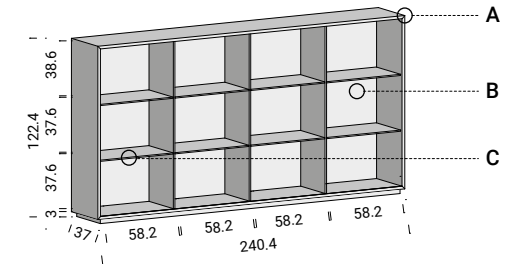

collection info  
pg. 26



## monolith MN06A

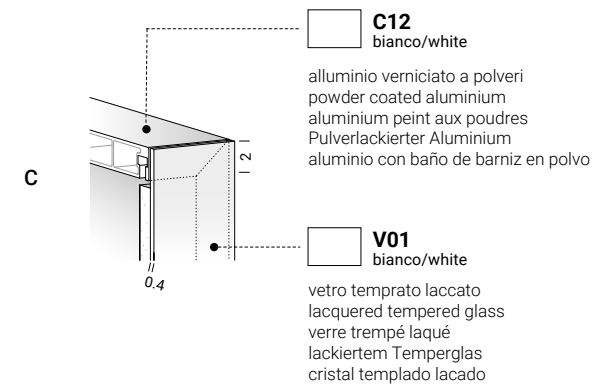
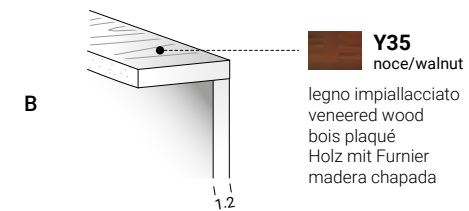
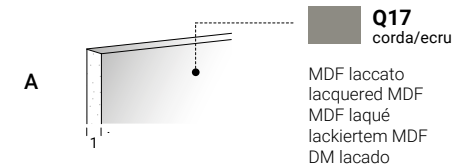
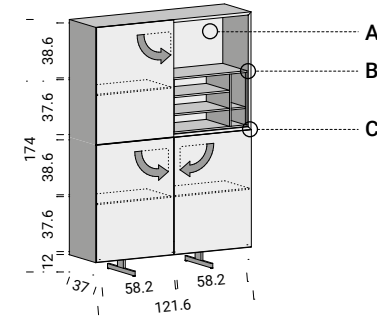

collection info  
pg. 26



## monolith MN06B

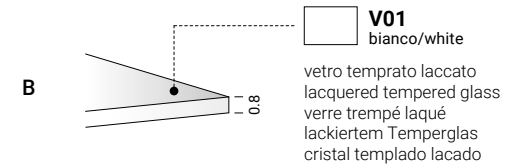
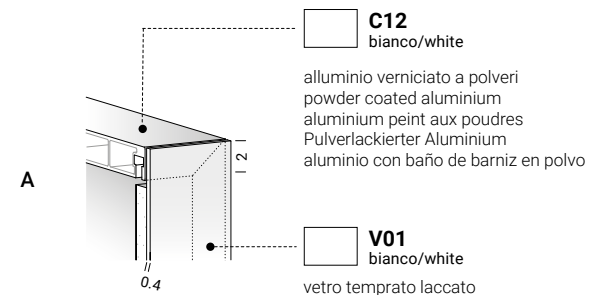
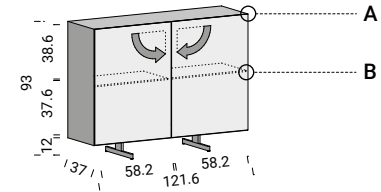

collection info  
pg. 26







## monolith MN04

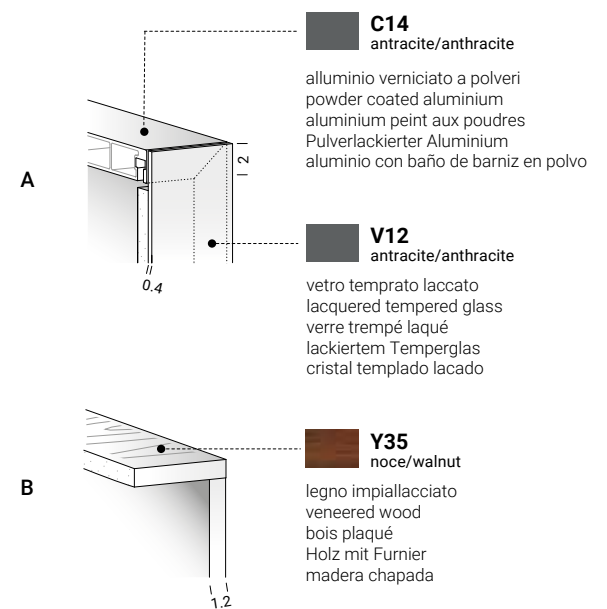
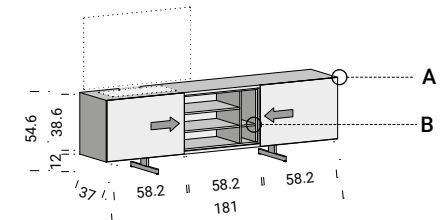

collection info  
pg. 26





## monolith MN01

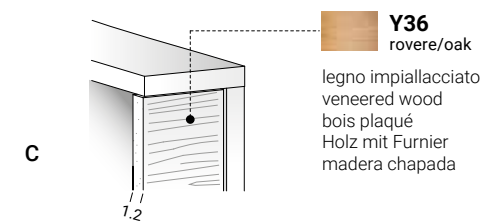
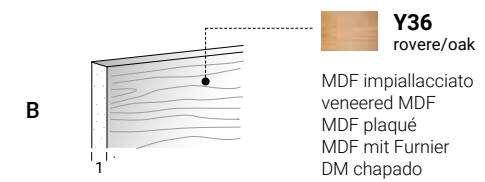
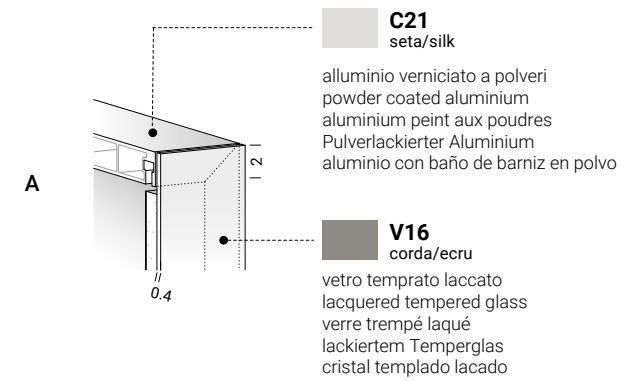
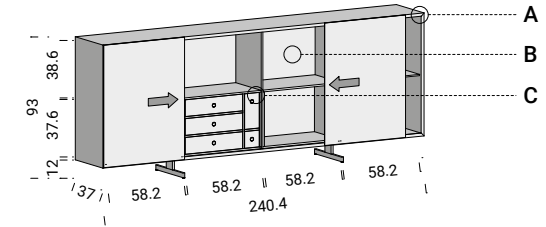

collection info  
pg. 26





**monolith**  
MN02A

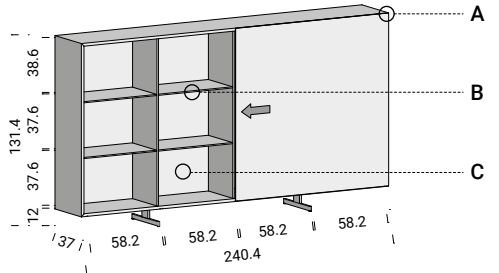

**A**

**C08**  
nero/black

alluminio verniciato a polveri  
powder coated aluminium  
aluminium peint aux poudres  
Pulverlackierter Aluminium  
aluminio con baño de barniz en polvo

**B**

**V02**  
nero/black

vetro temprato laccato  
lacquered tempered glass  
verre trempé laqué  
lackiertem Temperglas  
cristal templado lacado

**V06**  
fumè/smoked

vetro temprato  
tempered glass  
verre trempé  
Temperglas  
cristal templado

**C**

**Y36**  
rovere/oak

MDF impiallacciato  
veneered MDF  
MDF plaqué  
MDF mit Furnier  
DM chapado

collection info  
pg. 26





# monolith

MN05

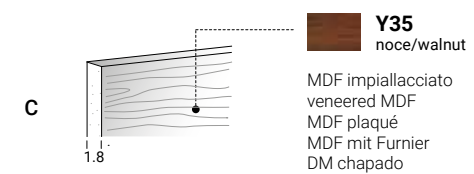
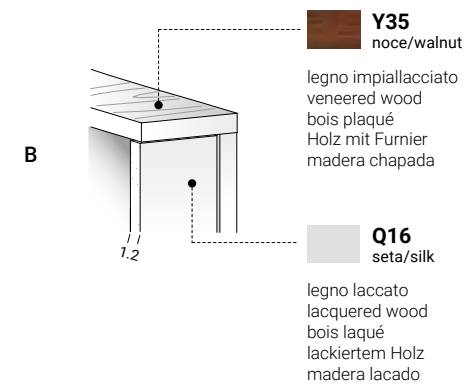
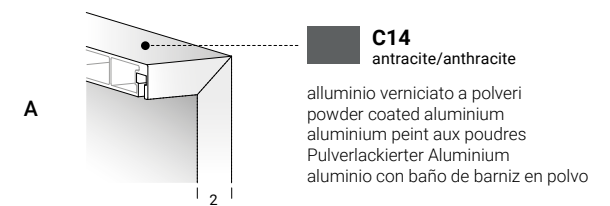
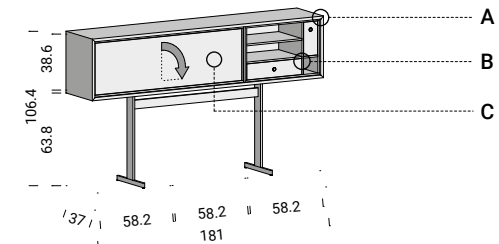

collection info  
pg. 26